

Preface	1
Introduction	1
The Owner's Handbook	1
Status at Time of Printing	1
Warranty.....	1
Symbols Used	2
In an Emergency.....	3
Vehicle Identification Information	4
Vehicle Identification	4
Vehicle Identification Label	5
Instructions for Use of Electric Vehicle	7
Effects of Ambient Temperature	7
Instructions for High Voltage Battery Pack Recycling	7
Driving Range.....	8
Equalisation Charging.....	9
High Voltage System.....	10
Precautions in the Event of an Accident	12
I Instruments and Controls	13

CONTENTS

Instruments and Controls	14
Instrument Pack	16
Message Centre	17
Warning Lights and Indicators.....	27
Lights and Switches.....	35
Master Light Switch.....	35
Headlamp Leveling Manual Adjustment.....	37
Direction Indicator/Main Beam Switch.....	38
Rear Fog Lamps.....	39
Hazard Warning Lamps	39
Wipers and Washers.....	40
Front Windscreen Wiper Operation.....	40
Rear Windscreen Wiper Operation.....	42
Steering System	44
Adjustment of Steering Column.....	44
Electric Power Steering	45
Horn.....	46
Mirrors	47

Door Mirrors.....	47
Interior Rearview Mirror.....	49
Sunvisor.....	51
Windows.....	52
Power Operated Window Switch.....	52
Window Operation.....	52
Interior Light.....	55
Front Interior Lamp.....	55
Automatic Operation.....	55
Power Socket.....	56
Front Console Power Socket.....	56
Rear Console USB Charging Ports *.....	57
Storage Devices.....	58
Instructions.....	58
Glove Box.....	58
Cubby Box.....	59
Glasses Box.....	59
Loadspace.....	60
Cup Holder.....	61

CONTENTS

Centre Console Cup Holder	61
Rear Armrest and Rear Cup Holder *	61
Roof Luggage Rack *	62
2 Air Conditioning.....	63
Ventilation	64
Particle/Pollen Filter	65
Vents	65
Electronic Temperature Control *	67
Control Panel.....	67
Interface Display.....	68
Blower Speed Control.....	68
Economy Mode.....	68
Cooling On/Off Button	69
Temperature Control.....	69
Air Distribution Mode.....	69
Defrost/Demist	70
Heated Rear Window	71
Air Recirculation Mode.....	71

Automatic Temperature Control *	72
Control Panel.....	72
Interface Display.....	73
System On/Off.....	73
Auto Mode.....	73
Economy Mode.....	74
Cooling On/Off Button	74
Temperature Control.....	74
Blower Speed Control.....	75
Air Distribution Mode.....	75
Defrost/Demist	76
Heated Rear Window	76
Air Recirculation Mode.....	77
3 Seats & Restraints	79
Seats	80
Overview	80
Head Restraints.....	80
Front Seats	81
Rear Seats	83

CONTENTS

Front Seat Heating *	84
Seat Belts	86
Protection Provided by Seat Belts	87
Wearing Seat Belts	88
Children and Seat Belts	92
Seat Belt Pre-tensioners	93
Seat Belt Checks, Maintenance and Replacement	94
Airbag Supplementary Restraint System	97
Overview	97
Airbag Deployment	98
Conditions in Which Airbags Will Not Deploy	101
Service and Replacement of Airbags	102
Disposal of Airbags	103
Child Restraints	105
Important Safety Instructions about Using Child Restraints	105
Child Restraints Groups	107
Approved Child Restraint Positions	110
4 Starting & Driving	115

Keys	116
Overview	116
Replacing the Key Battery.....	118
Child Proof Locks	120
Anti-theft Systems	121
Power Immobilisation	121
Body Anti-theft System	122
Tailgate.....	126
Starting and Stopping the Power System	128
START/STOP Switch	128
READY Mode.....	129
Switching the Power System OFF.....	131
Pedestrian Alert Control System	132
Economical and Environmental Driving	133
Running-in.....	133
Economic Driving and Maintenance	133
Driving in Special Environment.....	134
Vehicle Control	135
Vehicle Control System.....	135

CONTENTS

Power Limit of Electrical Appliances.....	135
Charging Requirements.....	137
Charging Your Vehicle at Home.....	139
Installed Charging Points.....	139
Home Charging Guide.....	139
Charging and Medical Condition Awareness.....	140
Charging Port.....	140
Rapid Charging.....	143
Slow Charging.....	143
Charging Information.....	147
Equalisation Charging.....	148
Charging Times.....	148
Electric Drive Transmission.....	151
Instructions.....	151
Gear Shift Control.....	151
Vehicle Start-off.....	154
Driving on Hills.....	155
Driving Mode (MODE).....	155
Energy Regeneration (KERS).....	157

Protection Mode.....	159
Brake System.....	161
Foot Brake.....	161
Electronic Hydraulic Brake Application System (EHBS).....	161
Hydraulic Booster Compensation System (HBC).....	162
Cooperative Regenerative Braking System (CRBS).....	162
Electronic Brake Force Distribution (EBD).....	163
Electronic Brake Assistance (EBA).....	163
Anti-lock Brake System (ABS).....	164
Hill Hold Control (HHC).....	165
Auto Hold.....	167
Emergency Braking Hazard Warning Lights Control System (HAZ).....	169
Electronic Parking Brake (EPB).....	169
Stability Control System (SCS) and Traction Control System (TCS).....	172
Tyre Pressure Monitoring System (TPMS).....	173
Cruise Control System *.....	175
Parking Aid.....	178
Ultrasonic Sensor Parking Aid.....	178
Parking Camera.....	179

CONTENTS

Load Carrying	181
Loadspace Loading.....	181
Internal Loading.....	181
5 Emergency Information	183
Hazard Warning Devices.....	184
Hazard Warning Lights	184
Warning Triangle.....	184
eCall - SOS Emergency Assistance	185
Emergency Starting	187
Using Booster Cables	187
Starting the Car	187
Vehicle Recovery.....	190
Towing Vehicle.....	190
Transporter or Trailer with Rope.....	193
Tyre Repair and Wheel Replacement	194
Tool Identification	194
Tyre Repair	194
Changing a Wheel *	197

Fuse Replacement	201
Fuse	201
Fuse Box	201
Bulb Replacement	209
Bulb Specification	209
Bulb Replacement	210
6 Maintenance	221
Maintenance	222
Routine Servicing	222
Bonnet	225
Opening the Bonnet	225
Closing the Bonnet	225
Bonnet Open Warning	225
Front Compartment	227
Cooling System	228
Coolant Check and Top Up-EDS	228
Coolant Check and Top Up-ESS	229
Coolant Specification	229

CONTENTS

Brake	231
Brake Pads	231
Brake Fluid Check and Top Up	231
Brake Fluid Specification	232
Battery	233
Battery Maintenance	233
Battery Replacement	233
High Voltage Battery Pack	235
Precautions and restricted conditions for use of battery	235
Washer	237
Windscreen Washer Fluid Check and Top Up	237
Washer Nozzles	238
Washer Fluid Specification	238
Wipers	239
Wiper Blades	239
Replacing Front Windscreen Wiper Blades	240
Replacing Rear Wiper Blades	241
Tyre	242
Overview	242

Caring for Your Tyres	244
Tyre Wear Indicators	244
Replacement of Tyres	245
Wheel Fitment Rotation	245
Tyre/Snow Chains	246
Cleaning and Vehicle Care.....	248
Exterior.....	248
Cleaning the Interior.....	251
7 Technical Data	253
Technical Data Dimensions	254
Weights.....	256
Major Parameters of High Voltage Battery Pack.....	257
Parameters of Traction Motor	258
Recommended Fluids and Capacities	259
Wheel Alignment (Unladen).....	260
Wheels and Tyres	260
Tyre Pressure (Cold)	260
Index.....	261

Introduction

The Owner's Handbook

This handbook describes all of the vehicles and standard equipment specification within the model range. Some of the information therefore, may not apply to your particular car.

Always remember that if you have any queries concerning the operation or specification of your car, your MG Authorised Repairer will be glad to advise you.

The illustrations in the Owner's Handbook are for reference only.

The information presented in this manual may vary slightly depending on vehicle configuration, software version and sales area.

Status at Time of Printing

MG operates a policy of constant product improvement and therefore reserves the right to change specifications without notice at any time. Whilst every effort is made to ensure complete accuracy of the information in this publication, no liabilities for inaccuracies or the

consequences thereof, including loss or damage to property, or injury to persons, can be accepted by the manufacturer or MG Authorised Repairer who supplied the publication, except in respect of personal injury caused by the negligence of the manufacturer or MG Authorised Repairer .

Warranty

Please consult www.mg.co.uk for the vehicle warranty terms and conditions, warranty statement and exemptions.

PREFACE

Symbols Used

The following symbols used within the handbook call your attention to specific types of information.

Warning



This warning symbol identifies procedures that must be followed precisely, or information that must be considered with great care, in order to reduce the risk of personal injury or serious damage to the car.

Important

IMPORTANT

The statements stated here must be followed strictly, otherwise your car could be damaged.

Note

Note: This describes helpful information.



This symbol indicates that parts described must be disposed of by authorised persons or bodies to protect the environment.

Asterisk

An asterisk (*) appearing within the text, identifies features or items of equipment that are either optional, or are only fitted to some vehicles in the model range.

Illustration Information



Identifies components being explained.



Identifies movement of components being explained.

In an Emergency

IMPORTANT

Remember the breakdown safety code

If a breakdown occurs while travelling:

- Wherever possible, consistent with road safety and traffic conditions, the car should be moved off the main thoroughfare, preferably into a lay-by. If a breakdown occurs on a motorway, pull well over to the inside of the hard shoulder.
- Switch on hazard lights.
- If available, position a warning triangle or a flashing amber light 50 to 150 metres (150 to 500 ft) behind your vehicle to warn approaching traffic. Note it is a legal requirement of some countries that a warning triangle is carried in the vehicle, if in doubt consult the local highways agency for further information.
- Consider evacuating passengers through nearside doors onto the verge to reduce risk of injury in the event of collision.

PREFACE

Vehicle Identification Information

Vehicle Identification

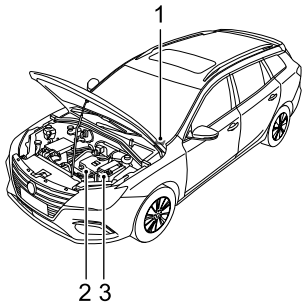

- 1 Vehicle Identification Number (VIN)
- 2 Drive Motor Number
- 3 Electric Drive Transmission Number

Always quote the Vehicle Identification Number (VIN) when communicating with MG Authorised Repairer. If the drive motor or electric drive transmission is involved, it

may be required to provide the identification numbers of these assemblies.

Vehicle Identification Location

Vehicle Identification Number (VIN)

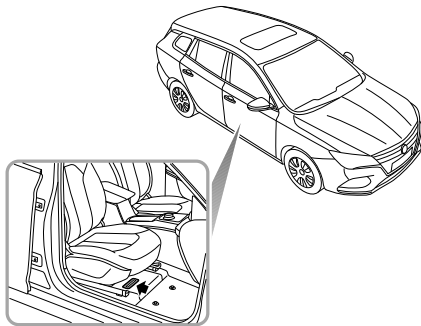

- On the floor under the driver's seat;
- On the identification plate;
- Stamped on a plate visible through the bottom left hand corner of the windscreen;

- On the inner side of the tailgate visible by opening the tailgate.

Note: The DLC is located in the driver footwell at the base of the fascia panel on the RH side. The VIN information can be extracted from the vehicle using the approved diagnostic equipment.

Drive Motor Number

Stamped on the lower part of the drive motor housing.

Electric Drive Transmission Number

Stamped on the upper part of the electric drive transmission housing.

Vehicle Identification Label

The Vehicle Identification Label contains the following information:

- Type Approval Number
- Vehicle Identification Number (VIN)
- Gross Vehicle Weight
- Gross Train Weight
- Max Front Axle Weight
- Max Rear Axle Weight
- Model
- Engine Type
- Date of Production
- Country

PREFACE

Location of Vehicle Identification Label

The Vehicle Identification Label is located at the lower side of passenger side B pillar.

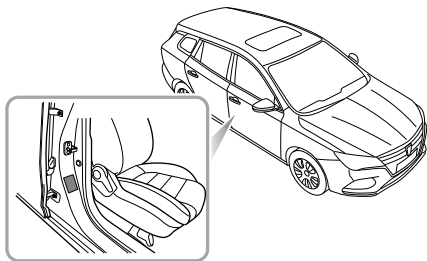

Instructions for Use of Electric Vehicle

Effects of Ambient Temperature

The working performance of the high-voltage battery pack fitted to your vehicle is related to the ambient temperature, this battery powers the vehicle power system and therefore it is recommended that where possible the vehicle should be used within the temperature range of -15 to 45°C. This will ensure that the vehicle is at the optimum working state, and help extend the service life of high-voltage battery pack. Extremely high or low temperatures will affect the performance of high-voltage battery pack and vehicle.

Instructions for High Voltage Battery Pack Recycling

The high-voltage battery pack fitted to your vehicle contains several lithium based battery cells, it is installed centrally to the motor-vehicle chassis. Arbitrary disposal may cause pollution, hazard and damage to the environment. The high-voltage battery pack **MUST** be recycled by an MG Authorised Repairer or a professional

approved dismantling agent. Please refer to the following information and requirements.

- **ONLY** qualified personnel should work with the high voltage system - there is danger of DEATH.
- High voltage safety: the high voltage system fitted to your vehicle features a HV battery containing high voltage components such as lithium battery packs and high voltage wiring harness; **DO NOT** attempt to dismantle any area of this system, suitably trained professional staff must observe insulation safety protection before working on or near the high voltage system.
- Transportation: The high-voltage battery pack is classed as a Category 9 hazardous material and must be transported by vehicles qualified in transporting Category 9 hazardous materials.
- Storage: All HV components (including batteries) should be stored at room temperature and in a dry environment. They must be kept away from dangerous sources, such as flammable objects, heat and water sources.

PREFACE

- Internal composition: The high-voltage battery pack consists of lithium batteries (pack), PCB, HV and normal electric wiring, metal casing and other components.

It is strongly recommended that the used high-voltage battery pack generated from vehicle scrappage or any other reasons should be disposed of by an MG Authorised Repairer. See official Website for details: www.mg.co.uk.

Note: Instructions: If you decide not to use the recommended MG Authorised Repairer to dispose of your high voltage battery, the responsibility of the consequences of environmental pollution or accidents must be borne by the owner.

Driving Range

The driving range of your vehicle depends on the HV battery condition, quantity of available electricity, vehicle age (current remaining battery life), weather, temperature, road conditions and driving habit etc.

The range can be affected by other electric loads (such as A/C, lights etc), driving style and general road conditions.

It should be noted that:

- The driving range is related to rate of discharge. In order to avoid a high rate of discharge from affecting the performance of the high-voltage battery pack, it is recommended that the vehicle is connected to a suitable charger upon illumination of the low battery warning lamp in the instrument pack.
 - The actual driving range of vehicle will reduce with the increase of vehicle age.
 - The use of A/C will reduce the driving range.
 - The driving range varies at different speeds.
 - At low temperatures, the driving range will be reduced due to temperature characteristics of the battery during use.
 - In some instances of extreme temperatures and low battery voltage, you may experience insufficient acceleration or power reduction, this is due to battery characteristics.
- To help increase the range of the vehicle please observe the following:
- Have the vehicle regularly maintained as per service schedule.
 - Always ensure the tyre pressures are correct.

- Try and use the vehicle between the recommended ambient temperatures.
- Do not park or store the vehicle for long periods with a low state of charge, where possible charge the vehicle as soon as possible prior to storage.
- Remove unnecessary articles to reduce the vehicle load.
- Use of high power consuming systems such as A/C and heating will use large amounts of power, this will reduce the driving range.
- At a high speed, where possible, close the windows to reduce wind resistance and power consumption.
- Try to maintain a steady speed at all times, avoid constant acceleration and braking.
- During acceleration, apply the accelerator pedal as gently as possible.
- During deceleration, release the accelerator pedal; under certain conditions when not applying the brake or gently applying the brake, the energy regeneration system (KERS) will assist in charging the HV battery and extend the driving range.

Equalisation Charging

In order to assist in extending the service life of the high voltage battery pack is recommended that an equalisation charge is carried out at regular intervals.

Please see "Equalisation Charging" in the "Starting & Driving" section.

PREFACE

High Voltage System



- *The high voltage system used on your vehicle features AC and DC voltages up to 410V. All high voltage components have warning labels attached - please observe these warnings and any requirements when operating within or close to these areas.*
- *ONLY qualified personnel should work on, or with, the high voltage system - there is danger of DEATH.*

The high voltage system component layout is shown below:

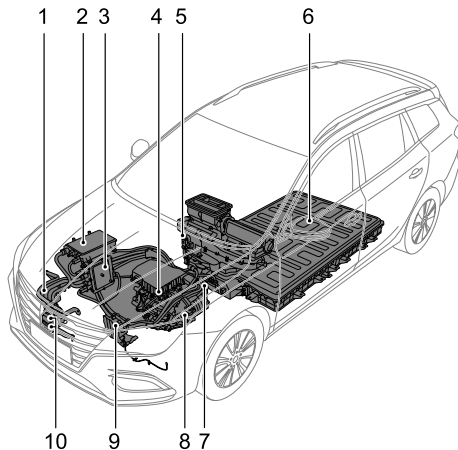

- 1 High Voltage Harness
- 2 Combined Charging Unit (CCU)
- 3 Power Distribution Unit (PDU)
- 4 Electric Drive Transmission
- 5 Electric Heater
- 6 High Voltage Battery (ESS)
- 7 Manual Service Disconnect (MSD)
- 8 Electric A/C Compressor
- 9 HV Battery Heater
- 10 Charging Port

PREFACE

Precautions in the Event of an Accident



- *Ensure the vehicle is in P, the parking brake is applied and the vehicle power system is OFF.*
- *If any cables on the vehicle are exposed, in order to prevent electric shock or even death DO NOT make any contact with any cable.*
- *If the vehicle catches fire, and the fire is small and slow, a carbon dioxide extinguisher can be used to extinguish the fire, and contact the fire services as soon as possible; if the fire is large and spreading quickly, immediately evacuate the vehicle and contact the fire services immediately.*
- *If the vehicle is involved in a collision and cannot be re-started, the Manual Service Disconnect (MSD) MUST be disconnected prior to rescue.*
- *When the vehicle is completely or partially immersed in water, switch off the vehicle power system and evacuate the car immediately. The Manual Service Disconnect (MSD) MUST be disconnected prior to rescue or as soon as the vehicle is refloated/removed from the water. Observe the water/vehicle for any abnormal signs such as excessive bubbles or noises, this may indicate battery short circuit issues, if no signs are evident there should not be a shock risk from the bodywork and recovery can commence.*
- *If your car is being recovered by an independent recovery agent, please contact MG Authorised Repairer for guidance.*
- *The vehicle is supplied with an emergency response information card (in the glove box). Please show the card to the rescue personnel when they arrive.*

Instruments and Controls

- | | |
|---|-------------------------------|
| <i>14 Instruments and Controls</i> | <i>58 Storage Devices</i> |
| <i>16 Instrument Pack</i> | <i>61 Cup Holder</i> |
| <i>17 Message Centre</i> | <i>62 Roof Luggage Rack *</i> |
| <i>27 Warning Lights and Indicators</i> | |
| <i>35 Lights and Switches</i> | |
| <i>40 Wipers and Washers</i> | |
| <i>44 Steering System</i> | |
| <i>46 Horn</i> | |
| <i>47 Mirrors</i> | |
| <i>51 Sunvisor</i> | |
| <i>52 Windows</i> | |
| <i>55 Interior Light</i> | |
| <i>56 Power Socket</i> | |

INSTRUMENTS AND CONTROLS

Instruments and Controls

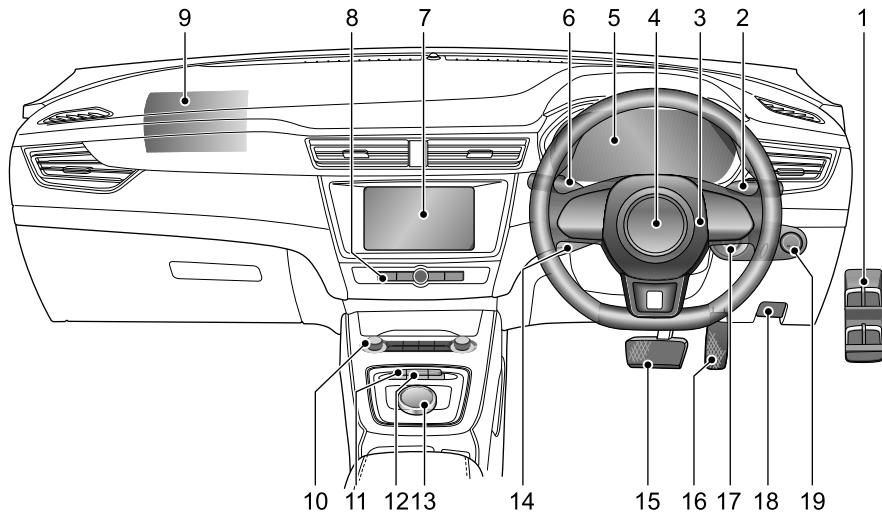

INSTRUMENTS AND CONTROLS

1

- 1 Power Window Switch
- 2 Wiper Stalk Switch
- 3 Horn Button
- 4 Driver Airbag
- 5 Instrument Pack
- 6 Direction Indicator/Main Beam Stalk Switch
- 7 Onboard Entertainment System
- 8 Entertainment Controls
- 9 Front Passenger Airbag
- 10 Air Conditioning Controls
- 11 Driving Mode Selection Switch
- 12 Energy Regeneration (KERS) Selection Switch
- 13 Shift Control Knob
- 14 Cruise Control Stalk Switch
- 15 Brake Pedal
- 16 Accelerator Pedal
- 17 Headlamp Levelling and Mirror Adjustment Switch
- 18 Bonnet Release Handle
- 19 START/STOP Switch

INSTRUMENTS AND CONTROLS

Instrument Pack

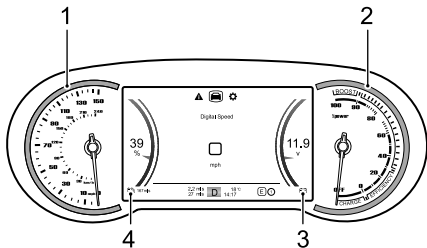

Speedometer (1)

Indicates the vehicle speed in mph and km/h.

Power Meter (2)

Indicates the power status of the power drive system as a percentage. The blue CHARGE segment indicates that the power drive system is converting part of the kinetic energy into electric energy; the green EFFICIENCY segment indicates that the vehicle is running using an economic

power output; the yellow BOOST segment indicates that the vehicle is running using a high power output.

Electricity Meter of Low-voltage Battery (3)

Displays the voltage of low-voltage battery.

Electricity Meter of High-voltage Battery Pack and Range to Empty (4)

Displays the current level of high voltage battery charge as a percentage and the remaining range of the vehicle before the high voltage battery becomes flat.

The high-voltage battery pack low battery warning lamp will illuminate when the high voltage battery charge is low. If the voltage continues to drop, this lamp will flash.

IMPORTANT

- When the high voltage battery indicator displays a low charge condition, connect to a charger and charge immediately.
- Before undertaking any journeys please ensure the high voltage battery contains enough power.

Message Centre

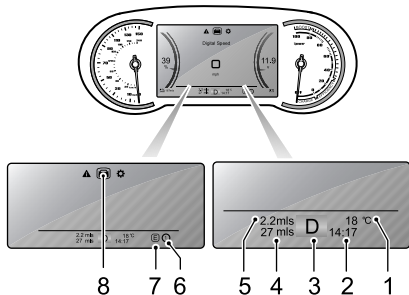

The message centre provides the following information:

- 1 Temperature
- 2 Digital Clock
- 3 Gear Display
- 4 Odometer

- 5 Accumulative Trip Meter
- 6 Energy Regeneration Level
- 7 Driving Mode
- 8 Vehicle Information Display

Temperature

Displays the current ambient temperature.

Digital Clock

Displays the current time.

Gear Display

Displays the current gear position (P, R, N, D).

If 'EP' is displayed, it indicates a serious functional failure with the gear shift system. In this case, please contact an MG Authorised Repairer immediately.

Odometer

Displays the total distance the car has travelled.

INSTRUMENTS AND CONTROLS

Accumulative Trip Meter

Displays the trip distance since reset.

Energy Regeneration Level

Displays the current energy regeneration level of the vehicle. For more information, please refer to "Energy Regeneration (KERS)" in "Starting & Driving" section.

Driving Mode

Displays the current driving mode of the vehicle. For more information, please refer to "Driving Mode (MODE)" in "Starting & Driving" section.

Vehicle Information Display

With the START/STOP Switch in the ON/READY position, the vehicle information display function can be selected as follows:

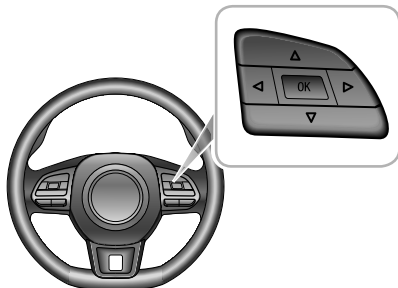

- Press the UP/DOWN/LEFT/RIGHT button in the RH steering wheel multifunction switch pack, this will access and display the general information options.
- Press the UP/DOWN button in the RH steering wheel multifunction switch pack to scroll through the options.
- Press the OK button in the RH steering wheel multifunction switch pack to confirm your option selection or long press the OK button to reset.

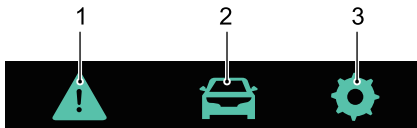

The vehicle information display contains the following information:

- 1 Warning Information
- 2 Trip Computer
- 3 Setting

Warning Information

Displays any warning information or important notes that are currently relevant to the vehicle.

Trip Computer

The trip computer function contains the following:

- Energy Flow
- Digital Speed: displays the current vehicle speed.

- Current Journey: displays the range, duration, average speed and average power consumption since startup. It can be reset by long pressing the "OK" button in the RH steering wheel multifunction switch pack.
- Accumulated Total: displays the range, duration, average speed and average power consumption since the last reset. It can be reset by long pressing the "OK" button in the RH steering wheel multifunction switch pack.
- Electric Information: displays the current operation state of the vehicle, including the voltage, current and motor speed.
- TPMS Monitor: Displays the current tyre pressures and temperatures.

INSTRUMENTS AND CONTROLS

Energy Flow

The energy flow interface automatically switches between display graphics to depict the current drive state. The display reverts to the default screen that displays no power flow when the vehicle power system is switched to the READY state. Other modes are as follows.

Energy Regeneration Mode

The motor recycles kinetic energy to charge the high-voltage battery pack.

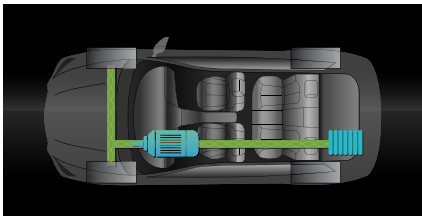

Electric Drive Mode

The vehicle is driven by motor.

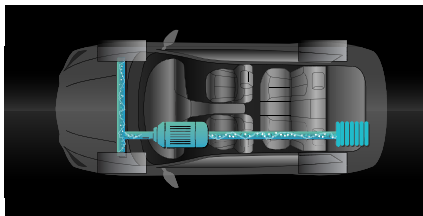

Setting

Luminance Level

Displays the current level and allows adjustment of the backlight brightness.

OverSpeed Threshold

Allows the setting of the over-speed alarm threshold, please note, the over-speed alarm function is turned off when "OFF" is displayed.

Warning Message

Warning messages and prompts are displayed in the information message centre in the instrument pack. Any communications are displayed in 'pop up' messages, these can be divided into the following categories:

- Operation Instruction
- System State Instruction
- System Malfunction Alert

Please follow the instructions displayed in the 'pop up' message or in the case of a warning message, please refer to the relevant section of the owners manual to follow the correct instructions.

The following are a selection of warning messages that may appear in the information message centre.

Warning Message	Action
Cruise Control System Fail	Indicates that the cruise control system has detected a fault. Please contact an MG Authorised Repairer as soon as possible.
Ignition System Fault	Indicates that the power mode has detected a fault. Please contact an MG Authorised Repairer immediately.
Start Stop Button Fail	Indicates that the START/STOP Switch has detected a fault. Please contact an MG Authorised Repairer immediately.
Passive Entry Fault	Indicates that the passive keyless entry function has detected a fault. Please contact an MG Authorised Repairer as soon as possible.

INSTRUMENTS AND CONTROLS

Warning Message	Action
ABS Fail	Indicates that the anti-lock brake system (ABS) has detected a fault, and the ABS function is about to be disabled. Please contact an MG Authorised Repairer immediately.
Brake Fail	Indicates that a fault has been detected within the braking system, such as brake fluid low/loss or Electronic Brake-force distribution failure has occurred, stop the vehicle as soon as safety permits switch the vehicle power system OFF, check the brake fluid level and contact an MG Authorised Repairer immediately.

Warning Message	Action
Stability Control System Fail	Indicates that the dynamic stability control system (SCS) has detected a fault. Please contact an MG Authorised Repairer immediately.
Traction Control System Fail	Indicates that the traction control system (TCS) has detected a fault. Please contact an MG Authorised Repairer immediately.
Park Brake Force Not Enough	Indicates that the electronic parking brake system has detected a fault when parking. Please contact an MG Authorised Repairer as soon as possible.
Autohold Fail	Indicates that the auto hold function has detected a fault. Please contact an MG Authorised Repairer as soon as possible.

INSTRUMENTS AND CONTROLS

1

Warning Message	Action
EPS Performance Decrease	Indicates that the electric power steering system (EPS) has a general failure and the performance is reduced. As soon as conditions permit, safely stop the vehicle and switch the vehicle power system to the OFF position. After a short while, switch the vehicle power system to the READY position, drive the vehicle a short distance and monitor the operation of the steering, if the message is still displayed or the steering assistance reduced please contact an MG Authorised Repairer immediately.

Warning Message	Action
Power Steering System Fault	Indicates that the electric power steering system (EPS) has failed. Please contact an MG Authorised Repairer immediately.
Steering Angle Sensor Fault	Indicates that the steering angle sensor has failed. Please contact an MG Authorised Repairer as soon as possible.
SAS Uncalibrated See Handbook	Indicates that the steering angle sensor is not calibrated. Please contact an MG Authorised Repairer as soon as possible.
ESCL Fault	Indicates that the ESCL system has detected a fault. Stop the car as soon as safety permits, shut down the engine and contact an MG Authorised Repairer immediately.

INSTRUMENTS AND CONTROLS

Warning Message	Action
Park Aid System Fault	Indicates that PDC system has detected a fault. Please contact an MG Authorised Repairer as soon as possible.
Airbag Fault	Indicates that the SDM has detected a fault. As soon as conditions permit, safely stop the vehicle and switch the vehicle power system to the OFF position and contact an MG Authorised Repairer immediately.
Airbag Lamp Fail	Indicates that the airbag lamp has failed. Please contact an MG Authorised Repairer as soon as possible.

Warning Message	Action
Tyre Pressure Monitoring Fail	Indicates that the tyre pressure monitoring system (TPMS) has detected a fault. Please contact an MG Authorised Repairer as soon as possible.
Front Left/Front Right/Rear Left/Rear Right Tyre Sensor Battery Low	Indicates that the TPMS has detected a sensor has a low battery. Please contact an MG Authorised Repairer as soon as possible.
Pedestrian Alert System Fault	Indicates that the pedestrian alert system has detected a fault. Please contact an MG Authorised Repairer as soon as possible.
DCDC Charge Fault	Indicates that the DC-DC converter (DCDC) has detected a fault. Please contact an MG Authorised Repairer immediately.

INSTRUMENTS AND CONTROLS

1

Warning Message	Action
12V Battery Charging System Fault	Indicates that the 12V battery charging system has detected a fault. Please contact an MG Authorised Repairer immediately.
Battery Maintenance Required Refer to Handbook	Please contact an MG Authorised Repairer immediately.
Check HV Battery	Indicates that the HV battery has detected a fault. Please contact an MG Authorised Repairer immediately.
Escape from the vehicle immediately!	As soon as conditions permit, safely stop the vehicle and evacuate all occupants immediately, and contact an MG Authorised Repairer immediately.

Warning Message	Action
System Fault	Indicates that the power system has detected a fault. Please contact an MG Authorised Repairer as soon as possible.
Motor Overheating	Indicates that the motor has overheated. Please contact an MG Authorised Repairer as soon as possible.
EDU Coolant Overheating	Indicates that the EDS coolant has overheated. Please contact an MG Authorised Repairer as soon as possible.
Motor Fault	Indicates that the drive motor has detected a fault. As soon as conditions permit, safely stop the vehicle and switch the vehicle power system to the OFF position and contact an MG Authorised Repairer immediately.

INSTRUMENTS AND CONTROLS

Warning Message	Action
eCall System Fault Consult Handbook	Indicates to the driver via a yellow SOS warning lamp that the eCall system has detected a fault and is not operating within its parameters. The SOS button LED status indicator flashes twice per second. Please contact a local MG Authorised Repairer as soon as possible.
eCall System Failure Consult Handbook	Indicates to the driver via a red SOS warning lamp that the eCall system has failed and is not capable of supporting in the event of an accident. The SOS button LED status indicator is not illuminated. Please contact a local MG Authorised Repairer immediately.

Warning Message	Action
eCall in Progress	Indicates to the driver via a green SOS warning lamp that an emergency services call is currently in progress. The SOS button LED status indicator flashes once per second.
Auto eCall Disabled Consult Handbook	Indicates to the driver via a red SOS warning lamp that automatic eCall service is disabled. Please contact a local MG Authorised Repairer to reactivate the automatic eCall function.

Warning Lights and Indicators

Some warning lamps illuminate or flash accompanied by a warning tone. Certain warning lamps will be accompanied by a momentary warning symbol and text message displayed in the information centre in the instrument pack.

Main Beam Indicator - Blue



This indicator illuminates when the headlamp high beam is turned on.

Side Lamp Indicator - Green



This indicator illuminates when the side lamps are on.

Rear Fog Lamp Indicator - Yellow



This indicator illuminates when the rear fog lamps are on.

Direction Indicators - Green



The left and right direction indicator lamps are represented by directional arrows that are located at the top of the instrument pack. When the turning signal lamp flashes, the direction indicator lamp on the corresponding side also flashes. If the hazard warning lamps are operated, both direction indicator lamps will flash together. If either direction indicator lamp in the instrument pack flashes very rapidly, it indicates that the turning signal light on the corresponding side has failed.

Note: *Failure of a side repeater lamp will have no effect on the flash frequency of direction indicator lamp.*

Airbag Warning - Red



If this lamp illuminates, it indicates that the SRS or the seat belt has failed. As soon as conditions permit, safely stop the vehicle and switch the vehicle power system to the OFF position and contact an MG

INSTRUMENTS AND CONTROLS

Authorised immediately. An SRS or seat belt fault may mean the components may not be deployed in the event of an accident.

Seat Belt Unfastened Warning Lamp - Red



If this lamp illuminates or flashes, it indicates that the seat belt for the driver or front passenger remains unfastened.



This vehicle is equipped with rear seat belt warnings to remind you to ensure any rear seat passengers have fastened their seat belts. The dedicated warning lamp consists of the 3 sections, 1 for each rear seat position, it will illuminate red on every ignition cycle and remain illuminated until a pre-set speed is reached and after a pre-set time period. If all 3 rear seat belts are fastened this lamp will extinguish immediately. When each individual rear seat belt is fastened the colour of that particular seat belt warning lamp will change from red to grey, the other seat positions will remain illuminated red, all 3 seat belt

warning lamps will extinguish after the pre-set speed is reached and the pre-set time has been surpassed.

Cruise Control Indicator - Green/Yellow



If the cruise control is switched on, the system will enter into standby state, and the indicator illuminates in yellow.

When the cruise control system operates, this indicator illuminates green, indicating the cruise control system is activated.

If a fault in the cruise control system is detected, the indicator will flash in yellow. Please seek an MG Authorised Repairer urgently.

Low-voltage Battery Charging System

Malfunction Warning - Red



When the vehicle power system is switched to the ON position this lamp illuminates as part of a self test, when the system is switched to READY the warning

light will extinguish. If the warning light illuminates whilst driving contact an MG Authorised Repairer at the earliest opportunity.

If the battery power is low, this lamp illuminates and a prompt message appears in the information centre. In this case, the system will restrict or turn off some electrical devices, please ensure the vehicle power system is in READY mode to charge the battery.

Stability Control/Traction Control System Operation and Fault Warning - Yellow



If this lamp illuminates, it indicates that the stability control system/traction control system has detected a fault. Please contact an MG Authorised immediately.

If this lamp flashes while driving, it indicates that the system is operating to assist the driver.

Stability Control/Traction Control System OFF

Warning - Yellow



If the stability control system/traction control system is switched off manually, this warning lamp will illuminate.

ABS Warning - Yellow



If this lamp illuminates, it indicates that the ABS has detected a fault. Please contact an MG Authorised immediately.

If an ABS failure occurs while driving, the ABS function will be disabled while normal braking will still be available. Please contact an MG Authorised immediately.

Brake System Warning - Red



This lamp is located in the speedometer face. If this lamp illuminates, it indicates a fault or issue has

INSTRUMENTS AND CONTROLS

been detected in the brake system such as brake fluid loss or electronic braking-force distribution failure. Please stop the vehicle as soon as safety permits, turn off the START/STOP Switch, check the brake fluid level (refer to "Brake Fluid Check and Top Up" in "Maintenance" section) and contact an MG Authorised immediately.

Booster System Warning - Yellow/Red



This lamp is located in the message centre. If the booster system detects a fault, this lamp illuminates yellow, please slow down, stop the vehicle as soon as safety permits and contact an MG Authorised Repairer immediately.

If the booster system suffers a serious failure, this lamp illuminates red, stop the vehicle as soon as safety permits, turn off the START/STOP Switch and contact an MG Authorised Repairer immediately.

Electric Power Steering (EPS)/ Electric Steering Column Lock (ESCL) Warning - Yellow/Red



The warning lamp is used to indicate electric power assisted steering failure or electronic steering column lock failure.

If this lamp illuminates yellow, it indicates the electric power assisted steering system has a general failure and the performance is reduced. Please stop the car as soon as safety permits. If the lamp still illuminates after restarting the vehicle and driving for a short while, please contact an MG Authorised Repairer immediately.

If this lamp illuminates red, it indicates the electric power assisted steering system has a general failure relevant to steering angle sensing. Please contact an MG Authorised Repairer as soon as possible.

If this lamp illuminates red and flashes, it indicates the electric power assisted steering system has a severe failure. Please contact an MG Authorised Repairer immediately.

If the lamp illuminates yellow and continually flashes accompanied with an audible warning, it indicates the electric steering column lock has detected a fault or failed. Please contact an MG Authorised Repairer as soon as possible. If this lamp extinguishes after flashing for a while, it indicates that the steering wheel is locked, please attempt to rotate the steering wheel to remove any adverse loads.

Tyre Pressure Monitoring System (TPMS)

Warning - Yellow



If this warning lamp illuminates it indicates that a tyre pressure is low, please check the tyre pressures.

If this lamp flashes first and then remains illuminated after a period of time, it indicates the system has detected a fault. Please contact an MG Authorised Repairer as soon as possible.

Immobiliser System Warning - Red



If no valid key is detected, this lamp will illuminate red. Please use the correct key, or put the smart key at the bottom of the centre console cup holder. For specific location requirements, refer to "Alternative Starting Procedure" in "Starting & Driving" section.

With the START/STOP Switch in the ON/READY position, if remote key battery is low, this lamp flashes, please replace the battery as soon as possible.

With the START/STOP Switch in the OFF position, the lamp flashes if the vehicle is fully armed or partially armed with security system.

Electronic Parking Brake (EPB)/ Auto Hold Status Indicator - Red/Green



If this lamp illuminates red, it indicates the EPB system is enabled. If this lamp illuminates red and flashes, it indicates that the EPB system has failed. Please contact an MG Authorised as soon as possible.

INSTRUMENTS AND CONTROLS

When the auto hold system is operating to assist the driver, this lamp illuminates green.

Electronic Parking Brake (EPB) System Malfunction Warning - Yellow



If an EPB system failure is detected or the system is under diagnosis, this lamp will illuminate. Please contact an MG Authorised as soon as possible.

READY Indicator - Green



This lamp is used to indicate that the vehicle is ready for driving.

Charging Status Indicator - Yellow



This lamp will illuminate when the vehicle is connected to a charge point, it will remain on during charging and extinguish after charging is completed.

Charging Connection Indicator - Red



This lamp will illuminate when the vehicle is connected to a charge point.

Power System Malfunction Warning - Red



This lamp will illuminate if a power system failure is detected. Please contact an MG Authorised as soon as possible.

Motor Overheat Warning - Red



This lamp will illuminate if the motor temperature is too high. Please contact an MG Authorised as soon as possible.

Motor Malfunction Warning - Red



If a fault or failure is detected in the motor or the power electronic box of electric drive system, this lamp

will illuminate. Please stop the vehicle as soon as safety permits, turn off the START/STOP Switch and contact an MG Authorised immediately.

High-voltage Battery Pack Low Battery Warning - Yellow



This lamp will illuminate when the high voltage battery charge is low, if the voltage continues to drop, this lamp will flash. Where possible please charge the high voltage battery before this lamp enters the flashing stage.

High-voltage Battery Pack Disconnection Warning - Yellow



When the high-voltage battery pack is connected, this lamp will not illuminate. This lamp will only illuminate when the high voltage battery is disconnected or isolated.

High-voltage Battery Pack Malfunction Warning

- Red



This lamp will illuminate if a fault is detected or the high voltage battery fails. Please contact an MG Authorised Repairer immediately.

This lamp will flash if the high voltage battery temperature is too high. Please stop the car as soon as safety permits, switch the vehicle power system to the OFF position, and leave the vehicle immediately. Contact an MG Authorised Repairer at the earliest opportunity.

If a high-voltage battery pack relay adhesion failure is recorded, this lamp flashes. Please contact an MG Authorised Repairer as soon as possible.

Driving Power Limited Warning - Yellow



This lamp will illuminate if the vehicle power has been reduced.

INSTRUMENTS AND CONTROLS

eCall SOS Indicator - Red/Yellow/Green



If the system is ready and an emergency services call (eCall) is in progress, the indicator illuminates green.

If the system is still capable of sending out a vehicle information message to the call centre, but other eCall capabilities are limited due to a fault in the system, the indicator will illuminate yellow. If the eCall system has failed and not operational, the indicator illuminates red. If the yellow or red indicator is illuminated permanently after system self-test, please contact an MG Authorised Repairer immediately.

System Fault Messages Indicator - Yellow/Red



This indicator is used to alert the driver of a stored warning, it is in yellow for general failures and in red for serious failures. Please refer to "Message Centre" in this section for these failures.

Lights and Switches

Master Light Switch

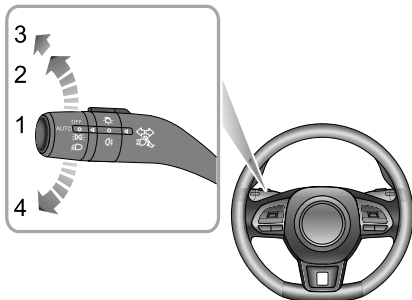

- 1 AUTO Lamp
- 2 Side Lamp and Switch Illumination
- 3 Dipped Headlamps
- 4 Lamps Off

AUTO Lamp

When the START/STOP Switch is in the ACC position, the auto lighting system defaults to the ON position (1). The AUTO lighting system will automatically switch the side lamps and switch illumination on and off according to the intensity of current ambient light.

With the START/STOP Switch in the ON/READY position, the AUTO lighting system will automatically switch the side lamps, switch illumination and dipped beam headlamps on and off according to the intensity of current ambient light.

Note: This function uses a light sensor that monitors exterior ambient light levels. For some models, the sensor is fitted in the centre of the fascia panel near the windscreen. **DO NOT** mask or cover this area. Failure to adhere to this may result in headlamps on when not necessary.

Side Lamp/Switch Illumination

Rotate the master light switch to position 2 to switch on the side lamps and switch illumination. With the START/STOP Switch in the OFF position, if the side lamps

INSTRUMENTS AND CONTROLS

stay on when the driver's door is opened, an audible alarm will sound.

Headlamps

When the START/STOP Switch is in the ON/READY position, rotate the master light switch to position 3 to switch on the dipped beam headlamps and side lamps.

Lamps Off

Rotate the master light switch to position 4 to switch off the lamps. Releasing the switch will allow it to return to the AUTO switch position

Follow Me Home

After the START/STOP Switch is turned off, pull the light lever towards the steering wheel. This will enable the Follow Me Home function, dipped beam headlamps and side lamps will illuminate depending upon the vehicle configuration. For some models, it can be set in the "Comfort and Convenience" in "Vehicle" settings on the entertainment display.

Daytime Running Lamps

The daytime running lamps illuminate automatically when the START/STOP Switch is in the ON/READY position.

Find My Car

After the vehicle has been left in a locked condition in excess of 2 minutes, pressing the lock button again on the remote key will enable the Find My Car function. This function will identify the car by means of an audible and visual alert. Pressing the Lock button on the handset again will suspend this operation. Pressing the Unlock button will cancel this operation.

Headlamp Leveling Manual Adjustment

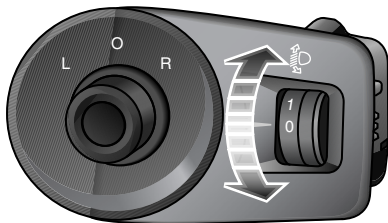

Position 0 is the initial position of the headlamp levelling adjustment switch. The headlamp leveling can be adjusted as per the following table according to the vehicle load.

Location	Load
0	Driver, or driver & front passenger
1	All the seats occupied with no load in the bootspace
2	All the seats occupied plus an evenly distributed load in the bootspace
3	Driver only, plus an evenly distributed load in the bootspace

INSTRUMENTS AND CONTROLS

Direction Indicator/Main Beam Switch



Take care not to dazzle oncoming vehicles when driving using main beam headlamps.

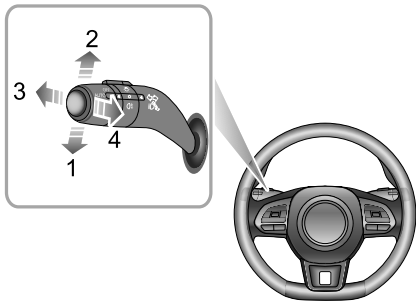

Direction Indicators

Move the light stalk switch down to indicate a LEFT turn (1). Move the light stalk switch up to indicate a RIGHT turn (2). The corresponding GREEN direction indicator in

the instrument pack will flash when the turn signal lamps are working.

Rotating the steering wheel will cancel the indicator operation (small movements of the steering wheel may not operate the self cancelling). To indicate a lane change, move the lever briefly and release, the indicators will flash three times and then cancel.

Main/Dipped Beam Headlamps Switching

With the START/STOP Switch in the ON/READY position and the headlamps on, push the light stalk switch towards the instrument panel (3) to turn on main beams. At this time, the main beam indicator in the instrument pack will illuminate and the message centre will prompt "Main Beam On". Push the light stalk switch (3) once again to switch to dipped beams.

Main Beam Flash

To briefly flash the main beam on and off, pull the lever towards the steering wheel (4) and then release.

Rear Fog Lamps



Fog lights should only be used when visibility is below 100m - other road users could be dazzled in clear conditions.

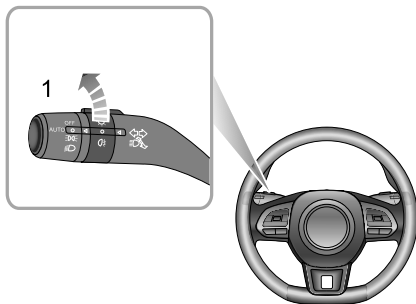

With the START/STOP Switch in the ON/READY position and the headlamps on, rotate the fog lamp switch to position I to turn on the rear fog lamps. The rear fog lamp

indicator illuminates in the instrument pack when the rear fog lamps are on.

Note: The rear fog lamps will turn off automatically when the master light switch is switched off.

Hazard Warning Lamps

Press the hazard warning lamp button  to turn on the hazard warning lamps. At this time, all turn signal lamps and direction indicators will flash together. Press the button again to turn off the hazard warning lamps. All turn signal lamps and direction indicators will stop flashing. For more details and location refer to 'Hazard Warning Devices' under 'Emergency Information'.

INSTRUMENTS AND CONTROLS

Wipers and Washers

Front Windscreen Wiper Operation

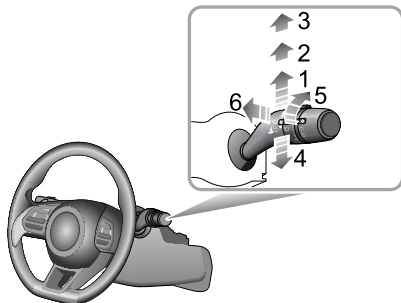

The front wipers and washers will only operate when the START/STOP Switch is in the ON/READY position. Operate the stalk switch to select different wiping modes:

- Intermittent wipe (1)
- Slow wipe (2)

- Fast wipe (3)
- Single wipe (4)
- Automatic wipe interval adjustment * / Rain sensor sensitivity adjustment *(5)
- Programmed wipe (6)

Intermittent Wipe

By pushing the lever up to the Intermittent wipe position (1), the wipers will operate automatically. Turn the switch (5) * to adjust the intermittent wipe frequency. This speed will also change with the vehicle speed. As the vehicle speed increases, the wiper frequency increases. As the vehicle speed decreases, the wiper frequency decreases.

Some models are equipped with a rain sensor fitted to the interior rear view mirror base to detect varying amounts of water on the outside of the windscreen. With Intermittent/Automatic selected, the vehicle will adjust the wiping speed according to the signals provided by rain sensor. Turn the switch (5) * to adjust the sensitivity of rain sensor. As the sensitivity increases, the wiping interval decreases.

Note: Immediately operating the wiper one time can be achieved by increasing the sensitivity of rain sensor. If the rain sensor detects continuous rainwater, the wiper will keep working. When no rain is detected, it is recommended to switch off automatic wipe.

Slow Wipe

By pushing the lever up to the slow speed wiping position (2), the wipers will operate slowly

Fast Wipe

By pushing the lever up to the fast speed wiping position (3), the wipers will operate at fast speed.

Single Wipe

Pressing the lever (4) down and releasing will operate a single wipe, if the lever is held down, the wipers will operate at high speed until the lever is released.

Note: When the vehicle is stationary, if the bonnet is opened, the front wiper/washer will stop working immediately.

IMPORTANT

- Avoid operating the wipers on a dry windscreen.
- In freezing or extremely hot conditions, make sure that the wiper blades are not frozen or adhered to the windscreen.
- In winter, remove snow or ice from around the arms and blades, including the wiped area of the screen before use.

Programmed Wipe

Pull the stalk switch toward the steering wheel (6), the windscreen washers will operate immediately. After a short delay, the wipers will commence operating in conjunction with the washers.

Note: The wipers continue operating for a further three wipes after the stalk switch is released. After several seconds, there will be a further wipe to remove any washer fluid from the screen.

INSTRUMENTS AND CONTROLS

IMPORTANT

If the washers fail to deliver the windscreen washer fluid, release the stalk switch immediately. This will prevent the wipers from operating, and the consequent risk of visibility being impaired by dirt smearing across the unwashed windscreen.

Rear Windscreen Wiper Operation

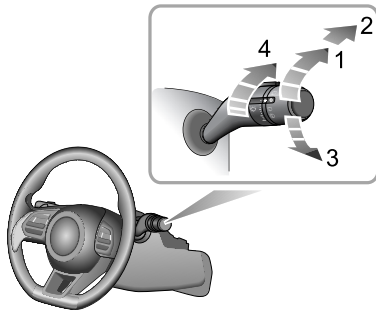

The rear wiper and washer will only operate when the START/STOP Switch is in the ON/READY position. Rotate the rear window wiper switch to your desired selection:

- Intermittent wiping (1)
- Wipe and wash (2)
- Wipe and wash (3)
- Wiper interval adjustment (4)

Intermittent wipe

Rotate the rear window wiper switch to intermittent wipe (1), the rear window wiper will operate, after several consecutive wipes, the wipers will enter into intermittent mode. The time period between the wipes can be increased/decreased via the intermittent wipe frequency adjustment switch (4).

Wash and wipe

Turn the rear window wiper switch to the wash and wipe (2) position and hold, the rear window wiper and washer will operate, the rear window wiper wipes quickly. release the switch allowing it to return to intermittent wipe (1), the rear window washer will stop operating, and the wiper wipes slowly, change the stalk switch position 4 to adjust the wipe speed. Turn the rear window wiper switch to wash and wipe (3) and hold, the rear window wiper and washer will operate. release the switch allowing it to return to the OFF position, the rear window washer will stop operating, and the rear window wiper wipes for 3 times, after several seconds, the wiper will wipe once more to remove the washer fluid on the rear screen.

Note: When the tail gate is opened, rear wiper operations will be disabled.

Note: When the front windscreen wipers are turned on, if the shift control knob is turned to R position, the rear wiper will operate.

INSTRUMENTS AND CONTROLS

Steering System

Adjustment of Steering Column



DO NOT attempt to adjust the height or angle of the steering column while the car is in motion. This is extremely dangerous.

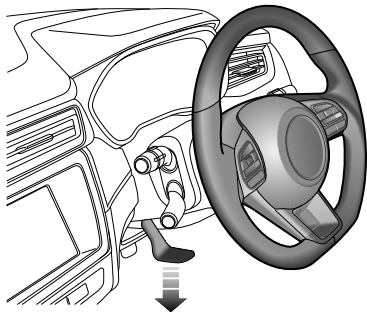

To adjust the angle or height of the steering column to suit your driving posture:

- 1 Fully release the locking lever.
- 2 Hold the steering wheel in both hands and tilt the steering column up or down to move the wheel into the most comfortable position.
- 3 Push or pull the steering wheel towards or away from the body.
- 4 Once a comfortable driving position has been selected, pull the locking lever fully up to lock the steering column into its new position.

Electric Power Steering



If the electric power steering fails or cannot operate the steering will appear very heavy, this will affect driving safety.

The electric power steering system only works when the vehicle is in READY mode. The system operates via a motor with assistance levels automatically adjusted based on vehicle speed, steering wheel torque and steering wheel angle.

IMPORTANT

Holding the steering wheel on full lock for long periods will result in a reduction in power assistance causing a heavier feel to the steering for a short period of time.

Electric Power Steering (EPS) Warning Lamp

Refer to "Warning Lights and Indicators" in "Instruments and Controls" section.

If the battery has been disconnected for any reason, upon reconnection the warning lamp will illuminate yellow. Movement of the steering wheel from lock to lock will initialise the system and the lamp will extinguish.

INSTRUMENTS AND CONTROLS

Horn



Press the horn button area (indicated by the arrow) on the steering wheel to operate the horn.

Note: *The vehicle horn button and the driver's airbag are located in close proximity on the steering wheel. The illustration shows the position of the horn (indicated by arrow), please ensure that you press*

in this area to avoid any potential conflict with the operation of the airbag.

IMPORTANT

To avoid possible SRS issues, please do not press with excessive force or hit the airbag cover when operating the horn.

Mirrors

Door Mirrors

Note: *Objects viewed in door mirrors may appear further away than they actually are.*

Electric Door Mirror Glass Adjustment

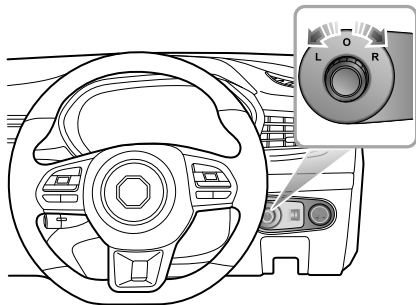

- Rotate the knob to select left (L) or right (R) door mirror.

- Move the knob in the desired direction to adjust the angle of the door mirror glass.
- Upon completion of the adjustment, rotate the knob back to the central position; this will ensure no accidental adjustment of the mirror.

Heating Elements *

The door mirrors have integral heating elements which disperse ice or mist from the glass. The heating elements operate while the Heated Rear Window  is switched on.

Note: *The heating elements of rear window and door mirror will only work when the power system is in READY mode.*

Mirror Folding

The mirrors can be folded back towards the side windows into a 'park' position to enable the car to negotiate narrow openings and avoid collisions.

INSTRUMENTS AND CONTROLS

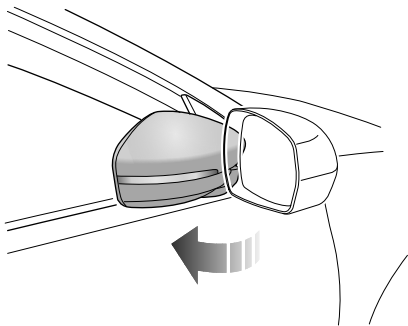

Manual Folding of Door Mirror *

For vehicles not fitted with the electric door mirror fold option, the exterior mirrors can only be folded backwards manually.

Electric Folding of Door Mirror *

For vehicles fitted with electric door mirror folding, rotate the knob to the middle position, and push the knob down. The door mirrors will be folded automatically. Pushing

the knob downwards again will return the mirrors to their original position.

Note: *Electrical folding door mirrors that have been moved from their positions by manual or accidental means must be reset by operating the knob to complete fold and deployment one time.*

IMPORTANT

- Door mirror glass adjustments are operated by electrical motors. Operating them directly by hand may damage the internal components.
- Washing or flushing door mirrors with high pressure water jets or car washes may result in electrical motor failure.

Interior Rearview Mirror

Adjust the body of the interior rearview mirror to achieve the best possible view. The anti-dazzle function of the interior rearview mirror helps to reduce glare from the headlamps of following vehicles at night.

Automatic Anti-dazzle Interior Mirror *

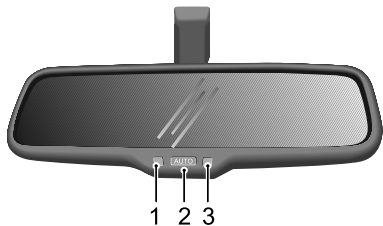

- 1 Operation Indicator
- 2 Automatic Anti-dazzle Function Switch
- 3 Light Sensor

After the car is placed in READY mode, the automatic anti-dazzle function is switched on automatically (operation indicator ON). If the system detects a following vehicle where the headlamps may dazzle the driver, the light sensor switches on the anti-dazzle function. Press the automatic anti-dazzle function switch (operation indicator OFF) to switch off the automatic anti-dazzle function, and press it again to re-start this function.

The automatic anti-dazzle function may be impaired or limited in the following situations :

- The lights of the following vehicle are not detected by the light sensor.
- Reserve gear is selected.

Note: *Attaching film on the rear window may have influences on the usage of automatic anti-dazzle function.*

INSTRUMENTS AND CONTROLS

Manual Anti-dazzle Interior Rearview Mirror*

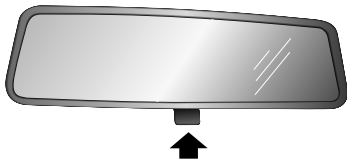

Move the lever at the base of the interior rearview mirror to change its angle, so as to achieve the anti-dazzle function. Normal visibility is restored by pulling the lever back again.

Note: *In some circumstances, the view reflected in a 'dipped' manual mirror can confuse the driver as to the precise location of following vehicles.*

Sunvisor



The vanity mirror on the driver side should only be used when the vehicle is stationary.

Sunvisor (1) and vanity mirror (2) are arranged on the roof ahead of both the driver and the front passenger. Certain models are fitted with vanity mirror lights (4) depending on the vehicle configuration.

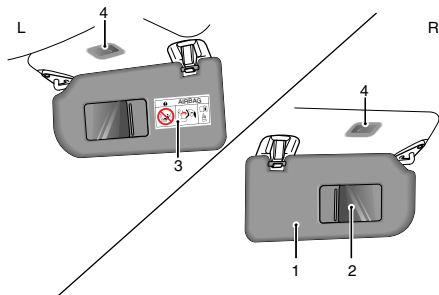

Pull the sunvisor downward to use the vanity mirror. If the roof has vanity mirror lights, the vanity mirror light is switched on when the cover is opened, and it is switched off when the cover is closed.

Note: Warnings and instructions on the use of a child restraint (3) are attached to both sides of the passenger sunvisor.

NEVER use rearward facing child restraints on a seat protected by an ACTIVE AIRBAG in front of it, DEATH or SERIOUS INJURY to the CHILD can occur.

INSTRUMENTS AND CONTROLS

Windows

Power Operated Window Switch

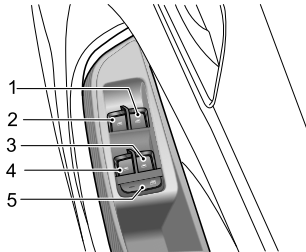

- 1 Front Right Window Switch
- 2 Front Left Window Switch
- 3 Rear Right Window Switch
- 4 Rear Left Window Switch
- 5 Rear Window Isolation Switch

Window Operation



Ensure children are kept clear when raising or lowering a window.



Improper use or activation of the electric windows by children could cause serious harm or even death. It is the responsibility of the driver and adult passengers to ensure that when carrying children the necessary steps are taken to isolate the window operation. This should include the removal of the key when children are left alone in the vehicle.

Push the switch (1-4) down to lower, and pull the switch up to raise the window. The window will stop moving as soon as the switch is released (unless the 'One-Touch' function is active).

Note: The front and rear passenger windows can also be operated by individual window switch, mounted on each door. The rear window switches will not operate if the rear window isolation switch has been activated.

Note: *The electric windows can be operated with the vehicle power system in the ACC, ON and READY positions. (For safety: doors should be closed).*

Rear Window Isolation Switch

Press the button (5) to isolate the rear window controls, press again to restore control.

Note: *It is recommended that you ISOLATE the rear window switches when carrying a child.*

“One-Touch” Down

The window control switch (1-4) has 2 positions. Short press the window control switch to the "2" position and release. The window automatically descends to fully open. Window movement can be stopped at desired position at any time by operating the corresponding switch during descent.

“One Touch” Up with “Anti-Trap”

Depending on vehicle specification, some windows may have the "One Touch" up function. Lifting the switch to the

"2" position for a short time and releasing will automatically close the window completely. Window movement can be stopped at a desired position at any time by briefly operating the switch again.

The “Anti-Trap” function is a safety feature which prevents the window from fully closing if an obstruction is sensed - if this happens the window will open slightly to allow the obstruction to be removed.

Note: *DO NOT operate the power window controls continuously several times in a short time frame, otherwise the power window controls may be disabled to protect the motor. If this occurs, please wait a few seconds until the motor cools down. In the case of the driver's window with "One Touch and Anti-Trap" please wait 30 seconds prior to operation. In some cases it may take 30 minutes to completely cool down, during which time the negative battery lead should not be disconnected.*

Note: *If the battery is disconnected, the “One-Touch” and “Anti-Trap” features will be lost. To restore this*

INSTRUMENTS AND CONTROLS

feature, fully open and then fully close the window holding the switch for 5 seconds in the closed position.

"Lazy Lock" Function *

The "Lazy Lock" function can open or close all the windows by using the remote key from outside the vehicle as long as it is within detection range.

Press and hold the remote key unlock button until the windows start to open, release the unlock button, all windows will open fully. With the windows open, press and hold the remote key lock button until the windows start to close, release the lock button, the windows will completely close.

Interior Light

Front Interior Lamp

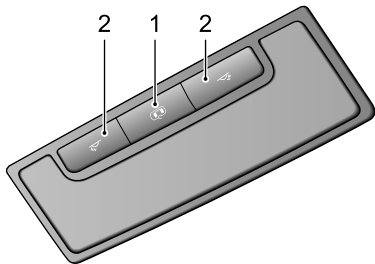

Manual Operation

Press one of the switches 2 to turn the corresponding courtesy light on, press again to switch off.

Automatic Operation

Press the switch (1) to select front courtesy lamp automatic operation, press again to turn off the function.

When the automatic operation is enabled, courtesy lights will illuminate automatically whenever the following occur.

- The car is unlocked.
- Any door is opened.

Note: *Under normal circumstances, if a door or the tailgate is left open for longer than 15 minutes, the courtesy lights will extinguish automatically. In case of low battery, the courtesy lights will extinguish quicker.*

INSTRUMENTS AND CONTROLS

Power Socket

Front Console Power Socket



Please ensure the socket lid is inserted when the power socket is not in use. This will ensure no debris or foreign objects enter the socket preventing its use or cause short circuits.

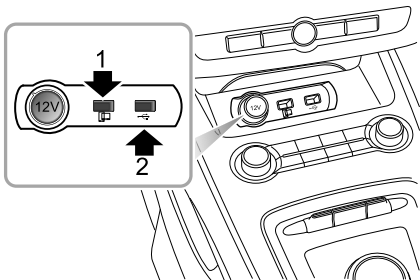

The 12V front console power socket is located in the storage box in front of the shift control knob. When

the START/STOP Switch is in the ACC or ON/READY positions, it can be used as a power supply.

There are 2 USB ports (1 & 2) equipped to the right of the 12V front console power socket. The USB ports can provide a 5V voltage when serving as a power outlet, or realize data transmission. USB port 1 can also provide 'Vehicle-Mobile Phone Interconnection' function.

Note: The voltage of the front console power socket is 12 volt, and the power rating is 120 watt. Do Not use electrical equipment with the power exceeding the rating.

Note: Due to configuration differences, some of the vehicle's USB ports may not support some fast charging devices.

Note: Extended use of the accessory power socket and USB socket when the vehicle power system is switched off will cause premature discharging of the vehicle battery.

Note: No cigarette lighter is available on the vehicle. If required, please consult an MG Authorised Repairer.

Rear Console USB Charging Ports *

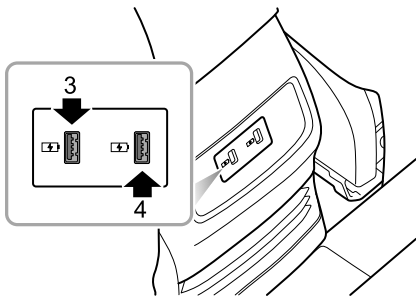

There are 2 USB ports (3 & 4) located on rear console plate, when the START/STOP Switch is in the ACC or ON/READY positions, the USB ports can provide 5V voltage serving as power outlets.

Note: Due to configuration differences, some of the vehicle's USB ports may not support some fast charging devices.

Note: Use of the front console power socket or USB port when the vehicle is not in READY mode will consume the battery power; extended use will cause premature discharging of the vehicle battery, and the vehicle may thus cannot be switched into READY mode.

INSTRUMENTS AND CONTROLS

Storage Devices

Instructions

- Please close all storage devices when the car is in motion. Leaving these storage devices open may cause personal injury in cases of a sudden start-off, emergency braking and a car accident.
- Do not place flammable materials such as liquid or lighters in any storage devices. The heat in hot conditions may ignite flammable materials and lead to a fire.

Glove Box

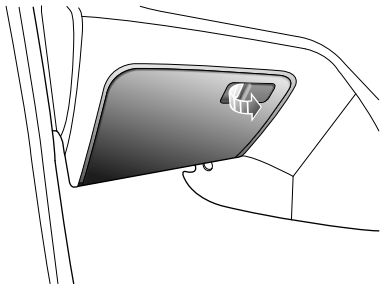

To open the glove box, pull the handle on the glove box cover (as indicated by the arrow).

Push the lid forward to close the glove box. Make sure the glove box is fully closed when the car is being driven.

Cubby Box

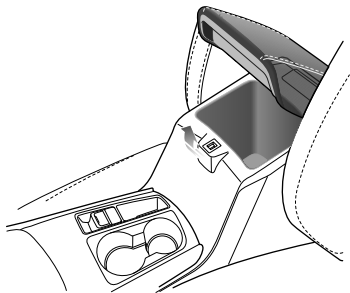

Lift the armrest (arrowed) to open the compartment cover.
Put the cover down to close it.

Glasses Box



The glasses box should only be used when the car is stationary.

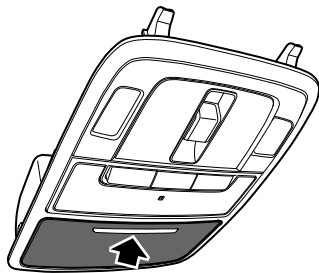

The glasses box is located in the proximity of the front interior lamps. Press the panel (as indicated by the arrow) to open the glasses box. Close the glasses box when it is not in use.

Note: *Not all glasses will fit inside the glasses box, fit is dependant upon frame type.*

INSTRUMENTS AND CONTROLS

Loadspace



DO NOT place articles on the rear parcel shelf, they could move causing personal injury in the event of an accident , emergency braking or hard acceleration.

The rear parcel shelf is connected to the tailgate using straps and hooks. When opening the tailgate, the shelf will automatically be raised.

The spare wheel/tyre repair kit and tool kit are stowed beneath the loadspace carpet, lift the carpet for access. Always refit the carpet after use.

Cup Holder



DO NOT place hot drinks in the cup holder whilst driving. Spillage may result in personal injury or damage.

Centre Console Cup Holder

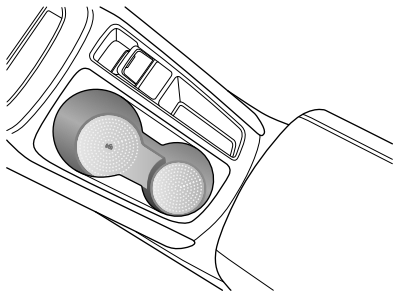

The centre console cup holder is situated at the front end of the centre console armrest assembly.

Rear Armrest and Rear Cup Holder*

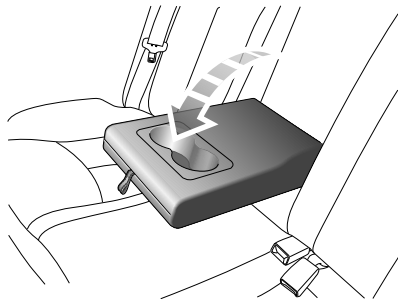

Fold forward to open the rear armrest. There are cup holders at the front end of the rear armrest.

INSTRUMENTS AND CONTROLS

Roof Luggage Rack *



The roof luggage rack is a non-load-bearing roof rack, which is used only as a decoration. Do not place any load on the roof luggage rack, otherwise it may result in an accident or damage to the vehicle.

Air Conditioning

64 *Ventilation*

67 *Electronic Temperature Control* *

72 *Automatic Temperature Control* *

AIR CONDITIONING

Ventilation

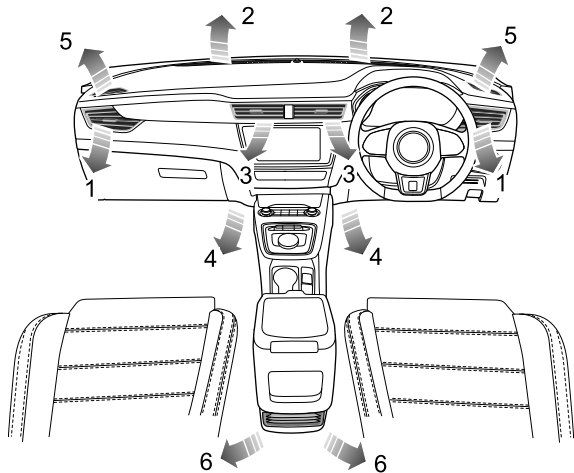

- 1 Side Vents
- 2 Windscreen/Defrost Vents
- 3 Centre Vents
- 4 Front Footwell Vents
- 5 Front Side Window Vents
- 6 Rear Footwell Vents

The heating, ventilation and air conditioning system provides fresh, cooling or heated air to the interior of the car. Fresh air is drawn in through the air intake grille at the base of the front windscreen and particle/pollen filter.

Always keep the air intake grille clear of obstructions such as leaves, snow or ice.

Particle/Pollen Filter

The particle/pollen filter helps to keep the car interior free from pollen and dust. To remain fully effective, the filter should be replaced at the recommended service interval.

Vents

Centre Vents

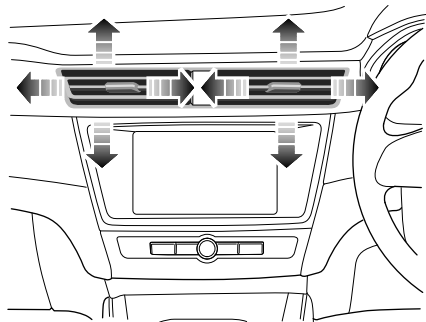

Slide the button in the centre of the louvres completely to the left or right to open or close the vent. Toggle it up and down, left and right to adjust the air direction.

AIR CONDITIONING

Side Vents

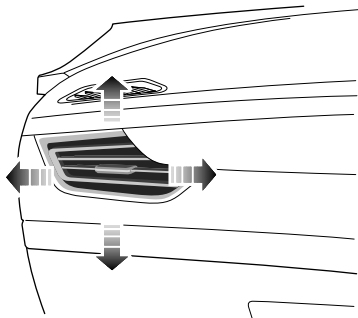

Slide the button in the centre of the louvres completely to the left or right to open or close the vent. Toggle it up and down, left and right to adjust the air direction.

Electronic Temperature Control *

Control Panel

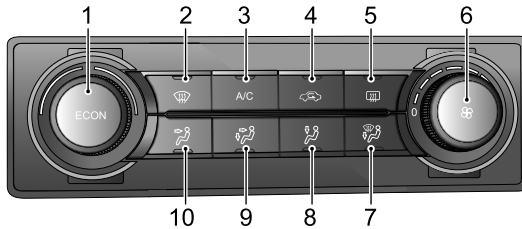

- 1 Temperature Control Knob/Economy Mode Button
- 2 Defrost/Demist Button
- 3 Cooling On/Off Button
- 4 Air Recirculation Mode Button
- 5 Heated Rear Window Button
- 6 Blower Speed Control Knob
- 7 Windscreen and Feet Mode Button
- 8 Feet Mode Button
- 9 Face and Feet Mode Button
- 10 Face Mode Button

AIR CONDITIONING

Interface Display

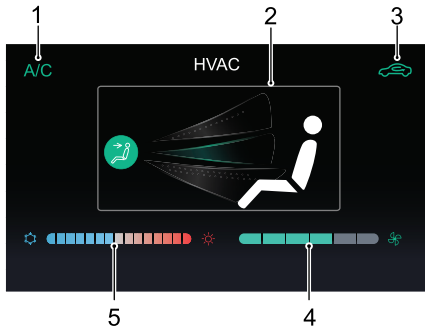

- 1 Cooling On/Off Display
- 2 Air Distribution Mode Display
- 3 Air Recirculation Mode Display
 - External circulation
 - Internal recirculation
- 4 Blower Speed Display

5 Temperature Display

Blower Speed Control

Rotate the blower speed control clockwise to increase the blower speed or rotate anti-clockwise to reduce the blower speed.

Note: Select *blower position 0* to switch the air conditioning system OFF. Rotate the *blower speed knob* to *blower speed 1* or above to switch the air conditioning system ON.

Economy Mode

ECON

Press the ECON button on the control panel, the air conditioning system will enter Economy Mode, the indicator in the button will illuminate. In Economy Mode, the air conditioning system will run at low energy consumption, so as to prolong the driving range.

Note:

- 1 Selection of ECON mode will impact situations that require maximum heating or cooling.
- 2 When the defrost/demist function is activated, the air conditioning system will automatically exit ECON mode, and the ECON mode indicator will extinguish.

Cooling On/Off Button



Press to operate; the indicator in the switch will illuminate indicating that the air cooling function is switched on. Press again to switch off.

Note:

- 1 The ventilation and heating function is still available when the air cooling is switched off.
- 2 The cooling/heating mode of the air conditioning will only operate when the vehicle is in the READY state

- 3 A small amount of water may remain in the air conditioner after usage, this may produce a peculiar smell. If this is a particular issue, it is recommended to switch off the cooling function and run the blower for a while.

Temperature Control





Rotate the Temperature Control Knob to adjust the air temperature inside the car.

Air Distribution Mode

Select the corresponding button to regulate the air distribution mode as required.

Operation Button	Interface display	Air Distribution Mode
		Face Mode
		Face and Feet Mode

AIR CONDITIONING

Operation Button	Interface display	Air Distribution Mode
		Face Mode
		Windscreen and Feet Mode

Face Mode : Directs air to the side and centre vents.

Face and Feet Mode : Directs air to side, centre and footwell vents.

Feet Mode: Directs air to the footwell vents.

Note: In this mode, a small amount of airflow will be directed to the side, windscreen/defrost and front side window vents.

Windscreen and Feet Mode: Directs air to the footwell, windscreen/defrost and front side window vents.

Note: In this mode, a small amount of airflow will be directed to the side vents.

Defrost/Demist



Press this button on the control panel to operate the defrost/demist function, the indicator will illuminate. The system will automatically set itself to a preset temperature and blower motor speed to effectively clear the side windows and windscreen.

Press again to switch off. Then the indicator will go off, and the system will return to the previous state.

Whilst the defrost/demist is selected, operate the A/C on/off button to turn the compressor on/off; operate the air recirculation button to switch between internal recirculation and external circulation, operation of either of these functions will not affect the defrost/demist function, operation of any other air distribution modes will quit defrost/demist.

Heated Rear Window



The heating elements on the inside of the rear window are easily damaged. DO NOT scrape or scratch the inside of the glass. DO NOT stick labels over the heating elements.



Press this button on the control panel to operate the heated rear window function, the indicator in the switch will illuminate. The heated rear window function will automatically turn off after operating for 15 minutes. If the switch is pressed again within 5 minutes, the heated rear window will operate and then remain on for a further 8 minutes. Pressing the switch whilst the heated rear window is on will switch off the function and extinguish the indicator in the switch.

Note: *The heated rear window will only operate when the vehicle is in the READY state.*

Air Recirculation Mode



Press the air recirculation mode button to switch the air recirculation mode to internal recirculation or external circulation. When the indicator illuminates, it is in the internal recirculation mode.

During internal recirculation, the air conditioning system circulates the air inside the car to meet the requirements of rapid cooling or heating, and at the same time, it can prevent the entry of traffic fumes.

During the external circulation, the air conditioning system draws air from outside the vehicle to ensure fresh air enters the vehicle.

Note: *Leaving the system in internal recirculation mode can cause the windscreen to mist. If this happens, turn on the defrost/demist mode, adjust the blower speed and air temperature to a reasonable range.*

AIR CONDITIONING

Automatic Temperature Control *

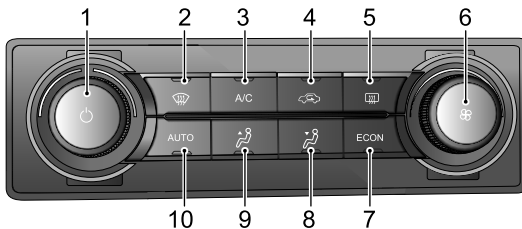

Control Panel

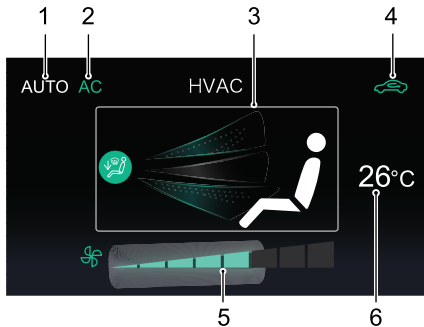

- 1 Temperature Control Knob/System On/Off Button
- 2 Defrost/Demist Button
- 3 Cooling On/Off Button
- 4 Air Recirculation Mode Button
- 5 Heated Rear Window Button
- 6 Blower Speed Control Knob
- 7 Economy Mode Button
- 8 Air Distribution Mode Button 1
- 9 Air Distribution Mode Button 2
- 10 Auto Mode Button

Interface Display



- 1 Auto Mode Display
- 2 Cooling On/Off Display
- 3 Air Distribution Mode Display
- 4 Air Recirculation Mode Display
 - External circulation 
 - Internal recirculation 

5 Blower Speed Display

6 Temperature Display

System On/Off



Press the System On/Off Button on the control panel to switch the system on, all functions will revert to the state before shutdown. Press again to switch off.

Note: The air conditioning system should only be switched off via the On/Off button.

Auto Mode



Set the target temperature required and then press the AUTO button to enable the auto mode function. In auto mode, the air distribution mode and the blower speed are automatically adjusted to reach and maintain the required temperature.

Note: To ensure the auto mode operates efficiently, all windows and the sunroof must be closed and the air inlet grille must be clear of obstruction. In addition,

AIR CONDITIONING

the solar sensor on the upper part of the instrument panel should not be covered.

Manually adjust the air distribution mode or blower speed to exit auto mode. In this case the AUTO indicator will extinguish.

Economy Mode

The image shows a black rectangular button with the word "ECON" written in white capital letters in the center.

Press the ECON button on the control panel, the air conditioning system will enter Economy Mode, the indicator in the button will illuminate. In Economy Mode, the air conditioning system will run at low energy consumption, so as to prolong the driving range.

Note:

- 1 Selection of ECON mode will impact situations that require maximum heating or cooling.***
- 2 When the defrost/demist function is activated, the air conditioning system will automatically exit ECON mode, and the ECON mode indicator will extinguish.***

Cooling On/Off Button

The image shows a black rectangular button with the letters "A/C" written in white capital letters in the center.

Press to operate; the indicator in the switch will illuminate indicating that the air cooling function is switched on. Press again to switch off.

Note:

- 1 The ventilation and heating function is still available when the air cooling is switched off.***
- 2 The cooling/heating mode of the air conditioning will only operate when the vehicle in the READY state***
- 3 A small amount of water may remain in the air conditioner after usage, this may produce a peculiar smell. If this is a particular issue, it is recommended to switch off the cooling function and run the blower for a while.***



Temperature Control



Rotate the Temperature Control Knob clockwise to increase the air temperature inside the car or rotate anti-clockwise to decrease.

Blower Speed Control

Rotate the blower speed control clockwise to increase the blower speed or rotate anti-clockwise to reduce the blower speed.

Air Distribution Mode

Select  and  to select the air distribution mode as required. You can select face mode, face and feet mode, feet mode or windscreen and feet mode.

Interface display	Air Distribution Mode
	Face Mode
	Face and Feet Mode
	Feet Mode

Interface display	Air Distribution Mode
	Windscreen and Feet Mode

Face Mode : Directs air to the side and centre vents.

Face and Feet Mode : Directs air to side, centre and footwell vents.

Feet Mode: Directs air to the footwell vents.

Note: In this mode, a small amount of airflow will be directed to the side, windscreen/defrost and front side window vents.

Windscreen and Feet Mode: Directs air to the footwell, windscreen/defrost and front side window vents.

Note: In this mode, a small amount of airflow will be directed to the side vents.

AIR CONDITIONING

Defrost/Demist



Press this button on the control panel to operate the defrost/demist function, the indicator will illuminate. The system will automatically set itself to a preset temperature and blower motor speed to effectively clear the side windows and windscreen.

Press again to switch off. Then the indicator will go off, and the system will return to the previous state.

Whilst the defrost/demist is selected, operate the A/C on/off button to turn the compressor on/off; operate the air recirculation button to switch between internal recirculation and external circulation, operation of either of these functions will not affect the defrost/demist function, operation of any other air distribution modes will quit defrost/demist.

Heated Rear Window



The heating elements on the inside of the rear window are easily damaged. DO NOT scrape or scratch the inside of the glass. DO NOT stick labels over the heating elements.



Press this button on the control panel to operate the heated rear window function, the indicator in the switch will illuminate. The heated rear window function will automatically turn off after operating for 15 minutes. If the switch is pressed again within 5 minutes, the heated rear window will operate and then remain on for a further 8 minutes. Pressing the switch whilst the heated rear window is on will switch off the function and extinguish the indicator in the switch.

Note: *The heated rear window will only operate when the vehicle is in the READY state.*

Air Recirculation Mode



Press the air recirculation mode button to switch the air recirculation mode to internal recirculation or external circulation. When the indicator illuminates, it is in the internal recirculation mode.

During internal recirculation, the air conditioning system circulates the air inside the car to meet the requirements of rapid cooling or heating, and at the same time, it can prevent the entry of traffic fumes.

During the external circulation, the air conditioning system draws air from outside the vehicle to ensure fresh air enters the vehicle.

Note: *Leaving the system in internal recirculation mode can cause the windscreen to mist. If this happens, turn on the defrost/demist mode, adjust the blower speed and air temperature to a reasonable range.*

Note: *When switching the system OFF, the vehicle automatically enters internal recirculation mode and the indicator illuminates.*

Seats & Restraints

80 *Seats*

86 *Seat Belts*

97 *Airbag Supplementary Restraint
System*

105 *Child Restraints*

SEATS & RESTRAINTS

Seats

Overview



To avoid personal injuries due to the loss of control, DO NOT adjust the seats while the car is moving.

An ideal position of the seat should make sure your driving position is comfortable, which allows you to hold the steering wheel with your arms and legs slightly bent and control all the equipment. Make sure your driving position is comfortable and enables you to maintain full control of the vehicle. Take care when adjusting the height of front seats - the feet of the rear passenger could become trapped when the seat is lowered.

DO NOT incline the front seat backrest excessively. Optimum benefit is obtained from the seat belt with the backrest angle set to approximately 25° from the upright (vertical). The driver and front passenger seats should be positioned as far rearward as practical. A properly adjusted seat helps reduce the risk of injury from sitting too close to an inflating airbag.

Head Restraints



Adjust the height of the head restraint so that the top of it is in line with the top of the occupant's head. This location may reduce the risk of head and neck injuries in the event of a collision. DO NOT adjust or remove the head restraints while the car is moving.



DO NOT hang anything on any head restraint or head restraint rod.

The head restraint is designed to prevent rearward movement of the head in the event of a collision or emergency braking, thereby reducing the risk of head and neck injuries.

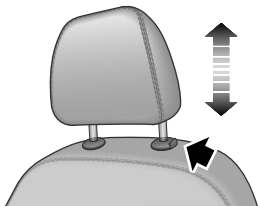

When adjusting a head restraint from low to high position, pull the head restraint directly upward, and gently press it downward after it reaches the desired position to make sure that it is locked in position. To remove the head restraint, press and hold the guide sleeve button (as indicated by the arrow) on the left of the head restraint, then pull the head restraint upward to remove it.

When adjusting a head restraint from high to low position, press the guide sleeve button (as indicated by the arrow) on the left of the head restraint, and press the head restraint downward; release the button after it reaches the desired position, and gently press the head restraint downward to make sure that it is locked in position.

Front Seats

Manual Seat

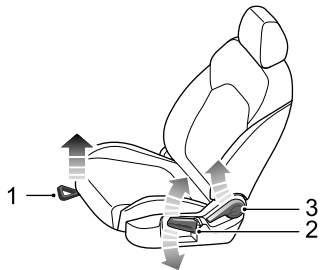

- Forward/Backward Adjustment

Lift the lever (1) under the seat cushion, slide the seat into an appropriate position and release the lever. Make sure that the seat is locked in place.

SEATS & RESTRAINTS

- Cushion Height Adjustment *

Lift the lever (2) repeatedly to raise the seat cushion, press the lever downward to lower the seat cushion.

- Backrest Adjustment

Lift the lever (3), adjust the backrest until it reaches the desired angle, return the lever to the rest position and ensure the backrest is in a locked position.

Power Seat *

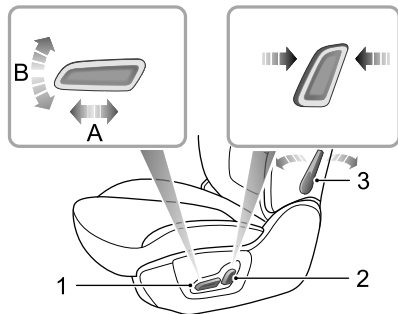

- Forward/Backward Adjustment

Push the switch (1) forward or backward (A) to move the seat forward/backward.

- Cushion Height Adjustment

Pull the switch (1) upward or push downward (B) to raise or lower the seat cushion.

- Backrest Adjustment

Move the switch (2) forward or backward to adjust backrest until it reaches the desired angle.

- Lumbar Support Adjustment

Move the lever (3) to adjust the level of the lumbar support.

Rear Seats

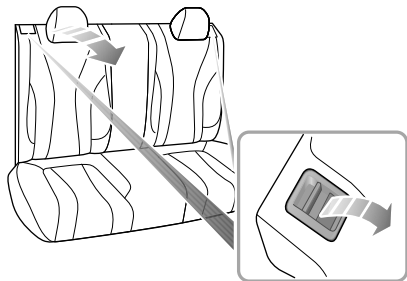

To increase the luggage space, the rear seat backrest can be folded fully forward. When folding the backrest completely, firstly insert the rear seat belt buckle into the corresponding slot, then fully lower (or remove) all head restraints, pull the respective control lever at the top of the seat backrest upwards and fold the seat backrest forward.

SEATS & RESTRAINTS

To return the backrest to an upright position, pull the respective control lever upward to release the lock, raise the backrest to the desired position, a click will be heard when the seat is locked.

Note: *When returning the rear seat backrest to the desired position, make sure that the rear seat belt is not trapped.*



Note: *If the rear seat head restraints are not fully lowered or the backrest of the front seat is inclined backward excessively, the folding of the rear seat is very likely to damage the back of the front seat, small storage compartment or rear seat head restraint.*

Note: *If the rear seat belt buckle is not completely inserted into the corresponding slot, folding the backrest is very likely to damage the rear seat backrest cover or foam.*

Front Seat Heating *



If bare skin is in contact with the heated seats for excessive periods of time, it may cause burns.

The seat cushion and backrest are provided with heating elements. After the vehicle power mode is set to READY, pressing  or  will activate the heaters.

When pressing a seat heater switch, the corresponding seat will become warm. Press the switch again to stop the heating function. When the seat heating function is activated, the operating indicator in the switch illuminates. When the cushion temperature reaches approximate 38°C or the backrest to approximate 40°C, the heating function will be deactivated automatically.

IMPORTANT

- DO NOT cover the heated seats with blankets, cushions or other insulation type objects or materials.
- If the seat cushion is heated up to 38°C or the seat backrest is heated up to 40°C and continues getting hotter when using the seat heating system, please turn off the seat heating and contact an MG Authorised Repairer.
- Overuse of the driver's heated seat may cause drowsiness and could affect safety.

SEATS & RESTRAINTS

Seat Belts



It is important that all seat belts are worn correctly. Always check that all passengers are wearing seat belts. DO NOT carry passengers that are unable to wear correctly positioned seat belts. Wearing seat belts incorrectly may cause serious injury or even death in the event of a collision.



Airbags can not replace seat belts. Airbags can only provide extra support when triggered, and not all traffic accidents will trigger airbags. Whether airbags are triggered or not, seat belts can reduce the risks of serious injury or death in accidents. Therefore, seat belts must be worn correctly.



NEVER unfasten a seat belt whilst driving. Serious injury or death may occur in the case of an accident or emergency braking.



This vehicle is equipped with seat belt warning lamp to remind you to fasten your seat belt.

During driving, seat belts must be fastened, this is because:

- You can never predict if you will be involved in a collision accident and how serious it may be.
- In many cases of collision accidents, passengers with seat belts correctly fastened are well-protected, while passengers with seat belts not fastened suffer from serious injury or even death.

Therefore, all passengers must wear seat belts correctly, even during short-distance journeys.

Protection Provided by Seat Belts



It is of equal importance for passengers in the rear seat to fasten their seat belts correctly. Otherwise, passengers with seat belts not correctly fastened will be thrown forward in accidents, and will endanger themselves as well as the driver and other passengers.

When the vehicle is in motion, the travelling speed of the occupants is identical to that of the vehicle.

In the event of a 'head on collision' or emergency braking, the vehicle may stop, but the occupants will carry on travelling until they come into contact with a stationary object. This object may be the steering wheel, dashboard, windscreen and others.

A correctly fastened seat belt will eliminate this risk of injury. When the seat belt is worn correctly, it will lock automatically in collision accidents or emergency braking to reduce your speed together with the vehicle, so as to prevent the out-of-control movement which may cause serious injury to driver and passengers.



SEATS & RESTRAINTS

Wearing Seat Belts



Incorrectly worn seat belts could cause injury or death in the event of an accident.



Seat belts are designed for one person. DO NOT share seat belts.



DO NOT wrap a seat belt around when holding a baby or child in your arms.



Remove any heavy coats or clothing when wearing a seat belt, failure to do so can affect protection provided by the seat belt.



Seat belts should not be wrapped around hard or sharp objects such as pens, spectacles or keys.



Seat belts cannot function correctly when the seats are reclined excessively. DO NOT drive when the seats are excessively reclined.

The seat belts fitted to your vehicle are designed for use by normal sized adults. This part of the literature refers to adult use. For advice on seat belt use with children, please see 'Children and Seat Belts'.

All seat belts are 3 point lap-shoulder belts.

In order to maintain effective protection, the passengers must sit in the correct orientation, feet placed on the floor in front of them, with an upright body (no excessive recline) and the seat belt correctly fastened.

Fastening Seat Belts

Please follow the instructions below to fasten the seat belts correctly.

- 1 Hold the metal tab, pull the seat belt out steadily over the shoulder and across your chest. Ensure the belt is not twisted.

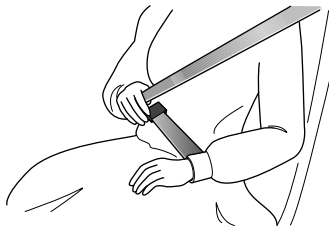

- 2 Insert the metal tab into the buckle until you hear a 'click', this indicates the seat belt is securely locked.

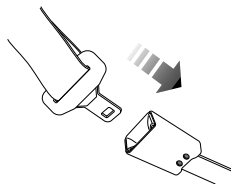

- 3 Remove any slackness in the belt by pulling up on the diagonal section of the belt.
- 4 To release the seat belt, press the red button on the buckle. The seat belt will retract automatically to its original position.

SEATS & RESTRAINTS

IMPORTANT

- Always ensure the seat belt will not become trapped in the door aperture when closing the door, damage will occur.
- Pulling the seat belt out too quickly may cause it to 'lock'. In this case, allow the seat belt to retract slightly and then pull it across your body slowly.
- If it is difficult to pull the seat belt out, it may be due to twisted webbing. If this is the case, fully extract the seat belt, remove the twist, allow the seat belt to retract slowly.
- When using the rear seat belts please ensure they are fully retracted into the correct position to avoid jamming in the rear seat catches. It is a legal requirement to wear seat belts. Even if the seat belt is twisted it must be worn. Where possible avoid the twisted section contacting the body and seek advice from an MG Authorised Repairer as soon as possible.

Correct Routing of the Seat Belts



Ensure the seat belt is correctly positioned on the body, NEVER cross the neck or abdomen, NEVER pass the seat belt behind the back or under the arms.

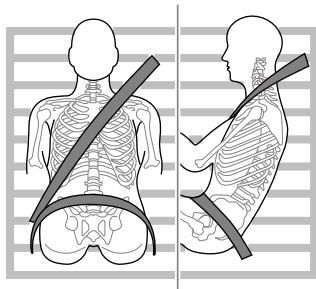

When wearing seat belts, the lap belt section should be positioned as low as possible across your hips. NEVER cross the abdomen. In the event of a collision, the lap belt can apply a force on the hips and reduce the possibility of

you slipping under the lap belt. If you slip under the lap belt, the belt will apply force on your abdomen, which may cause serious or fatal injuries. The diagonal section of the belt should cross the middle of the shoulder and the chest. In the event of emergency braking or collision, the diagonal section of the belt will be locked. NEVER position a seat belt across your neck, across the body under your arms or behind your back.

To ensure that the seat belts always provide maximum protection, ensure the belt is flat, not loose and contacts the body.

Seat Belts During Pregnancy

Wearing correctly positioned seat belts will provide protection for both mother and unborn child in the event of a collision or emergency braking.



The diagonal section of the seat belt should pass across the chest as normal, the lap section of the belt should pass below the belly, low and snug on the hip bones. NEVER position the belt on or above the belly.

Please consult your physician for further details.

Seat Belts and Disabilities

It is a legal requirement that all occupants wear seat belts, this include people with disabilities.

Depending upon the disability, consult your physician for further details.

SEATS & RESTRAINTS

Children and Seat Belts



Proper protection measures must be taken for children during driving.

For safety reasons, children must ride in a child restraint device fixed to the rear seat.

Infants



Only recommended child restraints suitable for the age, height and weight of the child should be used.



NEVER carry a child or infant with your arms during driving. When collision accidents occur, the weight of child will produce such a great force that you can not hold the child. The child will be thrown forward and suffer serious injury or even death.

The seat belts fitted to your vehicle are designed for adults, they are not suitable for children. In the event of an accident or collision the children are not secure, it could cause death or serious injury.

Infants **MUST** use a suitable child restraint device. Please consult the child seat manufacturers guide lines when selecting the correct seat. Follow the manufacturers instructions on installation. Please refer to "Child Restraints" in this chapter for more details.

Older Children



NEVER share a seat belt amongst children. In the event of an accident or collision the children are not secure, it could cause death or serious injury.

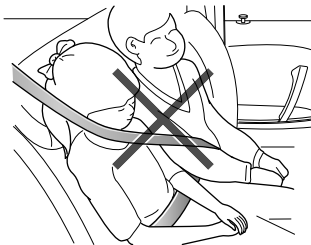

As children grow and become older/larger it will get to the stage when they no longer require child seat restraints, at this point they will require use of the vehicle standard seat belt. Please ensure the seat belt is correctly positioned on the body of the child.

When fastening a seat belt for a child always check it for correct positioning. Adjust the height of seat belt to ensure the shoulder belt is kept away from the child's face and neck. Position the lap belt across the hips as low as possible, and tighten adequately. Correct positioning means that the seat belts can pass the applied force to the strongest part of child's body in accidents.

If the shoulder belt is too close to child's face or neck, it may be necessary to use a child booster cushion (always ensure that it meets any relevant laws or standards.

Seat Belt Pre-tensioners



*The seat belt pre-tensioners will only be activated once and then **MUST BE REPLACED**. Failure to replace the pre-tensioners will reduce the efficiency of the vehicle's front restraint system.*



If the pre-tensioners have been activated, the seat belts will still function as restraints, and must be worn in the event that the vehicle remains in a drivable condition. The seat belt pre-tensioners should be replaced at the earliest opportunity by an MG Authorised Repairer.

The vehicle is fitted with seat belt pre-tensioners, these are designed to retract the seat belts and work in conjunction with the airbags in the event of a severe collision. They are designed to retract the seat belt and 'secure' the occupant in the seat.

The airbag warning light on the instrument pack will alert the driver to any malfunction of the seat belt

SEATS & RESTRAINTS

pre-tensioners.(see 'Warning Lamps and Indicators' in the 'Instruments and Controls' chapter).

The seat belt pre-tensioners can only be activated once, after activation they must be replaced. This may also involve replacement of other SRS components. Please refer to 'Replacing Airbag System Parts'.

IMPORTANT

- Seat belt pre-tensioners will not be activated by minor impacts.
- The removal or replacement of a pre-tensioner must be carried out by the manufacturer trained, dealer technicians.
- 10 years from the initial date of registration (or installation date of a replacement seat belt pre-tensioner), some components will need to be replaced. The appropriate page of the Service Portfolio must be signed and stamped, or the vehicle service records updated once the work has been completed.

Seat Belt Checks, Maintenance and Replacement

Seat Belt Checks



Split, worn or frayed seat belts may not function correctly in the event of a collision, if there are any signs of damage, replace the belt immediately.



Always ensure the red release button on the seat belt buckle is pointing upwards to ensure easy release in the event of an emergency.

Please follow the instructions below to check the seat belt warning lamp, seat belt, metal tab, buckle, retractor and fixing device regularly:

- Insert the seat belt metal tab into the corresponding buckle and pull seat belt webbing close to the buckle quickly to check that the belt clasp locks.
- Hold the metal tab and pull the seat belt forward quickly to check that the seat belt reel locks automatically, preventing the webbing from extending.

- Fully extract the seat belt and visibly examine for twists, fraying, splits or worn areas.
- Fully extract the seat belt and allow to return slowly to ensure continual and complete smooth operation.
- Visibly examine the seat belt for missing or broken components.
- Ensure the seat belt warning system is fully functional.

If the seat belt fails any of the above tests or inspections contact an MG Authorised Repairer immediately for repairs.

Seat Belt Maintenance



DO NOT attempt to remove, install, modify, disassemble or dispose of the seat belts. Have any necessary repairs carried out by your MG Authorised Repairer. Inappropriate handling may lead to incorrect operation.



Ensure no foreign or sharp objects become lodged in the seat belt mechanisms. DO NOT allow liquids to contaminate the seat belt buckle, this could affect the buckle engagement.

Seat belts should only be cleaned with warm soapy water. DO NOT use any solvent to clean the seat belt. DO NOT attempt to bleach or dye the seat belt, it may weaken the seat belt. After cleaning, wipe with a cloth and allow to dry. DO NOT allow the seat belt to fully retract before it is completely dry. Keep seat belts clean and dry.

If there are contaminants accumulated in the retractor, the retraction of the seat belt will be slow. Please use a clean and dry cloth to remove any contaminants.

SEATS & RESTRAINTS

Replacing Seat Belts



Collision accidents may damage the seat belt system. The seat belt system may not be able to protect users after damage and may cause serious injury or even death when an accident occurs. After the accident, seat belts should be checked immediately and replaced as necessary.

Seat belts should not require change after minor collisions, however, some other parts of the seat belt system may require attention. Please consult an MG Authorised Repairer for advice.

Airbag Supplementary Restraint System

Overview



*The airbag SRS provides **ADDITIONAL** protection in a severe frontal impact only. It does not replace the need, or requirement to wear a seat belt.*



The airbags together with the seat belts provide optimum protection for adults, but it is not the case for infants. The seat belt and airbag systems in the vehicle are not designed for protecting infants. The protection required by infants should be provided by child restraints.

The Airbag Supplementary Restraint System generally consists of:

- Front Airbags (fitted to the centre of the steering wheel and dashboard above the glove compartment)

- Seat Side Airbags (fitted to the outer side of the seat squab)
- Side Head Impact Protection Airbags (fitted behind the headlining)

Please note that this is model and trim level dependant.

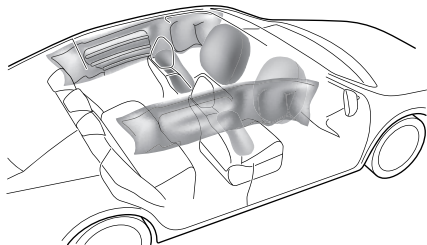

SEATS & RESTRAINTS

In the corresponding position where airbags are fitted, there is a warning sign stating 'AIRBAG'.

Airbag Warning Light



The airbag warning light is located in the instrument pack. If this lamp does not extinguish or illuminates during driving, it indicates that there is a failure in the SRS or seat belt. Please seek an MG Authorised Repairer at the earliest opportunity. An SRS or seat belt fault may mean the components may not be deployed in the event of an accident.

Airbag Deployment



Front seat passengers should not place feet, knees or any other part of the body in contact with, or in close proximity to a front airbag.



To minimise the risk of accidental injury from inflating airbags, seat belts should be worn correctly at all times. In addition, both driver and front seat passenger should adjust their seat to provide sufficient distance from the front airbags. If side airbags/side head impact protection airbags are fitted, both driver and front seat passenger should be seated to maintain sufficient distance from the upper part of the body to the sides of the vehicle, this will ensure maximum protection when the side airbags/side head impact protection airbags are deployed.



When airbags are deployed, children without proper protection may suffer from serious injury or even death. DO NOT carry children in the arms or on the knees during traveling. Children should wear seat belts suitable to age. DO NOT lean out of windows.



An inflating airbag can cause facial abrasions and other injuries if the occupant is too close to the airbag at the time of its deployment.



DO NOT affix or place any objects on, or adjacent to the airbags. This may affect the airbag passage or create projectiles that may cause injury or serious harm in the event of airbag deployment.



After deployment the airbag components become very hot. DO NOT touch any airbag related components, it may cause burns or serious injury.



DO NOT knock or strike the position where airbags or related parts are located, so as to avoid accidental airbag deployment which may cause serious injury or even death.

In the event of a collision, the airbag control unit monitors the rate of deceleration or acceleration induced by the collision, to determine whether the airbags should be deployed. Airbag deployment is virtually instantaneous and occurs with considerable force, accompanied by a loud noise.

Provided the front seat occupants are correctly seated and with seat belts properly worn, the airbags will provide additional protection to the chest and facial areas in the event of the car receiving a severe frontal impact.

Side airbags and side head impact protection airbags are designed to offer additional protection to the side of the body facing the impact, if a severe side collision occurs.

SEATS & RESTRAINTS

IMPORTANT

- Airbags can not protect lower body parts of passengers.
- Airbags are not designed for rear collision, minor frontal or side impacts, or if the vehicle overturns; nor will it operate as a result of heavy braking.
- Deployment and retraction of the frontal and side airbags takes place very quickly and will not protect against the effects of secondary impacts that may occur.
- When an airbag inflates, a fine powder is released. This is not an indication of a malfunction, however, the powder may cause irritation to the skin and should be thoroughly flushed from the eyes and any cuts or abrasions of the skin.
- After inflation, front and side airbags deflate immediately. This provides a gradual cushioning effect for the occupant and also ensures that the driver's forward vision is not obscured.

Front Airbags



NEVER use a rearward facing child restraint on a seat protected by an ACTIVE AIRBAG in front of it, DEATH or SERIOUS INJURY to the CHILD can occur.



Front seat passengers should not place feet, knees or any other part of the body in contact with, or in close proximity to a front airbag.



In extreme cases driving on very uneven surfaces may cause airbag deployment. Please take extra care when driving on uneven roads.

Airbags are designed to deploy during serious impacts, the following conditions may cause airbag deployment.

- A frontal collision with unmovable or non deformable solid objects at a high speed.
- Conditions that can cause serious chassis damage, such as a collision with kerbstones, road edges, deep ravines or holes.

Seat Side Airbags



The manufacture and material of the seat is critical to the correct operation of side airbags. Therefore, please DO NOT fit seat covers which may affect side airbag deployment.

In the event of a serious side impact, the relevant side airbag will deploy (only the affected side).

- The airbag will be deployed in the event that the side of the vehicle is impacted with a solid object or another vehicle.

Side Head Impact Protection Airbags

In the event of a serious side impact, the relevant side curtain airbag will deploy (only the affected side).

- The side curtain airbag will be deployed in the event that the side of the vehicle is impacted with a solid object or another vehicle.

Conditions in Which Airbags Will Not Deploy

The deployment of airbags does not depend on the vehicle speed, but on the object that the vehicle hits, angle of impact and the rate at which the car changes speed as a result of a collision. When the impact force of collision is absorbed or dispersed to vehicle body, airbags may not deploy; however, airbags may sometimes deploy according to impact condition. Therefore, the deployment of airbags shall not be judged based on the severity of vehicle damage.

Front Airbags

Under certain conditions the front airbags may not be deployed. Some examples are listed below:

- The impact point is not central to the front of the vehicle.
- The impact is not of sufficient force (the impact is with an object that is not solid, such as a lamp post or central barriers).
- The impact area is high (collision with the tailgate of a truck).
- Impacts to the rear or side of the vehicle.

SEATS & RESTRAINTS

- The vehicle rolling over.

Seat Side Airbags and Side Head Impact Protection Airbags

Under certain conditions the seat side and side head airbags may not be deployed. Some examples are listed below:

- Side impacts at certain angles.
- Light side impacts such as a motorcycle.
- Impacts that are not central to the side of the vehicle, either too far toward the front compartment or the loadspace.
- The vehicle rolling over.
- The angled impact is not of sufficient force (the impact is with an object that is not solid, such as a lamp post or central barriers).
- The impact is not of sufficient force (with another vehicle, stationary or moving).
- The impact is from the rear of the vehicle.

Service and Replacement of Airbags

Service Information



DO NOT install or modify the airbag. Any changes to the vehicle structure or airbag system wiring harness are strictly prohibited.



Changes to vehicle structure is prohibited. This may affect the normal operation of the SRS.



DO NOT allow SRS areas to be flooded with liquid and DO NOT use petrol, detergent, furniture cream or polishes to clean SRS components..



If water contaminates or enters the SRS it may cause damage and affect deployment. In this case contact an MG Authorised Repairer immediately.

To prevent damage to the airbag SRS, the following areas should be cleaned sparingly with a damp cloth and upholstery cleaner **ONLY**:

- Steering wheel centre pad.
- Area of dashboard containing the passenger airbag.
- Area of roof lining and front pillar finishers which enclose the side head impact protection modules.

If the airbag warning lamp fails to illuminate, stays on, or if there is damage to the front or side of the vehicle, or the airbag covers show signs of damage, contact an MG Authorised Repairer immediately.

IMPORTANT

- The removal or replacement of an airbag module should be carried out by an MG Authorised Repairer.
- After 10 years from the initial date of registration (or installation date of a replacement airbag), some components will need to be replaced by an MG Authorised Repairer. The appropriate page of the Service Portfolio must be signed and stamped, or the vehicle service records updated once the work has been completed.

Replacing Airbag System Parts



Even if the airbag does not deploy, collisions may cause damage to SRS in the vehicle. Airbags may not function properly after damage, and can not protect you and other passengers when a second collision occurs, which may cause serious injury or even death. To ensure that the SRS can function properly after a collision, please go to an MG Authorised Repairer to check airbags and repair as necessary.

Airbags are designed for using once only. Once the airbag is deployed, you must replace SRS parts.

Please go to an MG Authorised Repairer for replacement.

Disposal of Airbags

When your vehicle is sold, ensure that the new owner knows the vehicle is equipped with airbags, and is aware of the replacement date of SRS.

SEATS & RESTRAINTS

If the vehicle is scrapped, the undeployed airbags may have potential risks, therefore, before the disposal, they must be deployed safely in a certain environment by a professional from an MG Authorised Repairer.

Child Restraints

Important Safety Instructions about Using Child Restraints

It is recommended that children below the age of 12 years old should be seated on the rear seat of the vehicle, in a child restraint system appropriate to the children's weight and size. Infants less than 2 years old should be restrained in an infant child restraint system.

It is recommended that a child restraint system that complies with UN ECE-R44 or ECE-R129 standard are fitted in this vehicle. Check markings on the child restraint system.

There are a number of child restraint systems available of different type and specification. For optimum protection, it is recommended that you choose restraint systems appropriate to the child's age and weight.

It is important to comply with installation instructions supplied by the child restraint manufacturer and that child restraint system is properly secured to the vehicle. Failure to follow these instructions may cause death or serious injury to the child in an event of a sudden stop or accident.

- All occupants, including children must wear seat belts or use an appropriate child restraint.
- MG strongly recommends that children under 12 years of age or less than 1.5 metres tall should use the appropriate child restraint fitted to the rear seat.
- Only one child can be carried in any one restraint.
- **DO NOT** put the child on the lap or in arms when sitting in any seat.
- Always adjust the seat back rest to a central position and ensure it is locked in position when installing a child seat or restraint.
- If installing a rear facing child restraint to the rear seat, the corresponding front seat should be adjusted forward; if installing a forward facing child restraint to the rear seat, you may need to adjust the height of the headrest to the lowest; if installing a forward facing child restraint to the front seat, you may need to remove its headrest.
- Never let your child stand or kneel on the seat during driving.
- Always ensure the child is seated correctly in the child restraint.

SEATS & RESTRAINTS

- The ways of using seat belts have a great influence on the maximum protection offered by the seat belt, you must comply with the child restraint manufacturer's instructions on proper use of seat belts. If seat belts are not properly fastened, a minor traffic accident may also lead to injury.
- Child restraints that are not fitted correctly may move and injure other occupants in the event of an accident or emergency braking. Therefore, even if there is no infant or child in the child restraint, it also should be fitted properly and securely in the vehicle.

Warnings and Instructions on Use of Child Restraint on Front Passenger Seat



NEVER use a rearward facing child restraint on a seat protected by an ACTIVE AIRBAG in front of it, DEATH or SERIOUS INJURY to the CHILD can occur.



If you choose to install a child restraint on the front passenger seat, move the front passenger seat as far rearward as possible.



Use one child restraint per child.

Please study the safety warning label on the sun visor. Where possible always install child restraints on the rear seat. If it is necessary to install a child restraint on the front seat please observe the warnings above.

Children's Safety and Side Airbags



Children should not be allowed in areas where airbags may be deployed, there is a risk of serious injury.



Only recommended child restraints suitable for the age, height and weight of the child should be used.



DO NOT place any items in areas where airbags may be deployed, there is a risk of serious injury.

In the event of a side collision, the side airbags can provide better protection for the passenger. However, when the airbag is triggered a very strong expansion force is generated, if the passenger's seating position is not correct, the airbags or items in the side airbag deployment area may cause injury.

When the correct child restraint is used to secure the child properly in the rear seat and the child's seating position is correct, there is enough space between the child and the side airbag deployment region for the airbag to deploy without any hindrance, and thus provide the best protection.

Child Restraints Groups

Secured Using 3 Point lap Diagonal Belts



Please DO NOT put the rear facing child restraint in the front passenger seat, this may cause serious injury or even death.

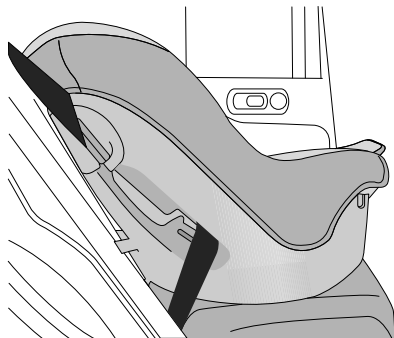

SEATS & RESTRAINTS

It is recommended that children should always be seated in the rear of the vehicle in a child restraint or restraint system, and fixed with 3 point, lap diagonal seat belts.

ISOFIX Child Restraint Systems



The ISOFIX anchorages in the rear seat are designed for use with ISOFIX systems only.



Child restraint anchorages are designed to withstand only those loads imposed by correctly fitted child restraints. Under no circumstances are they to be used for adult seat belts, harnesses, or for attaching other items or equipment to the vehicle.

Note: When installing and using any child restraint system, always follow the manufacturer's instructions.

Note: The rear seats fitted to this vehicle are provided with the ISOFIX interface (as indicated by the arrow in the following image), these are designed to connect to an ISOFIX child seat.

- 1 Fasten vehicle-approved ISOFIX child restraint systems to the mounting brackets.
- 2 When using ISOFIX mounting brackets for seat mounting, universally approved child restraint systems for ISOFIX may be used.

SEATS & RESTRAINTS

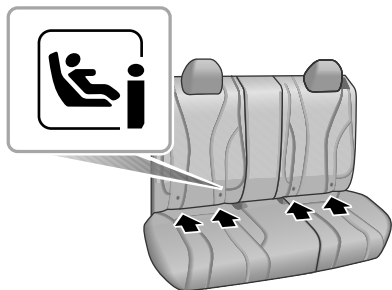

- 3 To fasten the Top tether strap of the child restraint system, route the tether strap under the head restraint and attach to the anchorage hook being careful not to twist the strap. If not using ISOFIX lower anchorages, using the seatbelt, complete the installation in line with the child restraint manufactures instructions.

Note: *When using seat mounting, universally approved child restraint systems, Top tether must be used.*

- 4 After installation apply suitable force to ensure the restraint is securely fastened.

Note: *Please refer to the child restraint system manufacturer's instructions for details.*

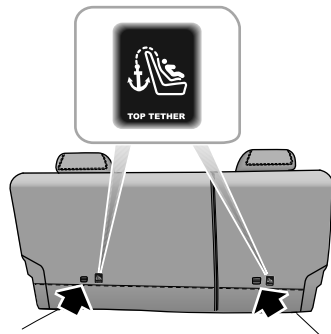

SEATS & RESTRAINTS

Approved Child Restraint Positions

It is recommended that a child restraint system that complies with UN ECE-R44 or ECE-R129 standard are fitted in this vehicle. Check markings on the child restraint system.

Approved Child Restraint Positions (for non ISOFIX Child Restraints)

Mass Group	Seating Positions		
	Front Passenger	Rear Outboard	Rear Middle
0 group (less than 10 kg)	X	U	U
0+ group (less than 13 kg)	X	U	U
I group (9 ~ 18 kg)	X	U	U
II group (15 ~ 25 kg)	X	U	U
III group (22 ~ 36 kg)	X	U	U

Note: Description of letters in the table:

U = Suitable for universal child restraint systems approved for this mass group;

X = Seat position not suitable for child restraint systems in this mass group.

Approved Child Restraint Positions (for ISOFIX Child Restraints)

Seating Position		Mass group categories			
		0 group	0+ group	I group	
		Rear facing		Forward facing	Rear facing
		Up to 29 lbs(13 kg)		20–40 lbs(9 ~ 18 kg)	
Front Passenger Seat	Size Class	Not ISOFIX equipped			
	Seat Type				
Rear Outboard Seat ISOFIX	Size Class	C,D,E ¹	A,B, BI ¹	C,D ¹	
	Seat Type	IL ²	IL ² ,IUF ³	IL ²	
Rear Centre Seat	Size Class	Not ISOFIX equipped			
	Seat Type				

Note: IL = suitable for particular ISOFIX child restraints of the semi-universal category. Please refer to the vehicle list recommended by child restraints manufacturer;

IUF= suitable for forward-facing ISOFIX child restraints of universal category approved for use in this mass group and ISOFIX size class;

¹ The ISOFIX size class for both universal and semi-universal child restraints is defined by the capital letters grade A to G. These identification letters are displayed on the ISOFIX child restraints;

SEATS & RESTRAINTS

² At time of publishing the recommended group 0+ ISOFIX child restraint is the Britax Romer Baby Safe Plus;

³ At time of publishing the recommended group I ISOFIX child restraint is the Britax Romer Duo Plus.

Note: At time of publishing the recommended Group II-III ISOFIX child seat is the KidFix XP.

Table of I- Size child seats

The table gives a recommendation for which I- Size child seats suit which locations, and for what size of child.

The child seat must be approved in accordance with UN Reg R129.

Type of child seat	Front passenger seat	Rear outboard seats	Rear centre seat
I- Size child restraint systems	X	I-U	X

Note: I-U Suitable for use with forward and rear facing I- Size child restraint systems.

X Not suitable for use with I- Size restraint systems.

Group 0/0+ Child Restraint



When the front passenger airbag is active, never place a rear facing child restraint on the front passenger seat, severe injury or even death can occur.

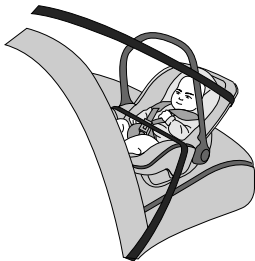

Child restraints that can be adjusted to lying position are most suitable for infants who are lighter than 10 kg (normally for those younger than 9 months) or those who are lighter than 13 kg (normally for those younger than 24 months).

Group I Child Restraint



When the front passenger airbag is active, never place a rear facing child restraint on the front passenger seat, severe injury or even death can occur.

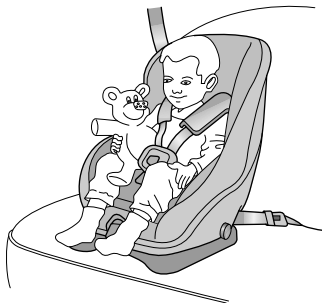

Backward/forward child restraints are most suitable for infants whose weight is 9 ~ 18 kg (normally for those older than 9 months and younger than 4 years old).

SEATS & RESTRAINTS

Group II Child Restraint



The diagonal section of the seat belt should pass across the shoulder and upper body, away from the neck. The lap section of the belt should pass across the hips, away from the abdomen.



The combination of child restraint and 3 point lap diagonal seat belt is most suitable for children whose weight is 15 ~ 25 kg (normally for those older than 3 years old and younger than 7 years old).

Group III Child Restraint



The diagonal section of the seat belt should pass across the shoulder and upper body, away from the neck. The lap section of the belt should pass across the hips, away from the abdomen.



The combination of child booster seat and vehicle 3 point lap diagonal seat belt is most suitable for children whose weight is 22 ~ 36 kg and whose height is below 1.5 m (normally for those about 7 years old or those older than 7 years old).

Starting & Driving

116 Keys

120 Child Proof Locks

121 Anti-theft Systems

128 Starting and Stopping the Power System

132 Pedestrian Alert Control System

133 Economical and Environmental Driving

135 Vehicle Control

137 Charging Requirements

151 Electric Drive Transmission

161 Brake System

172 Stability Control System (SCS) and Traction Control System (TCS)

173 Tyre Pressure Monitoring System (TPMS)

175 Cruise Control System *

178 Parking Aid

181 Load Carrying

STARTING & DRIVING

Keys

Overview



Please keep the spare key in a safe place - not in the vehicle!



It is recommended that spare keys are not kept on the same key ring, since this may cause interference and prevent correct key recognition and therefore prevent the vehicle power system from entering READY mode.



The smart key contains delicate circuits and must be protected from impact and water damage, high temperature and humidity, direct sunlight and the effects of solvents, waxes and abrasive cleaners.

Two smart keys shall be provided. Both of them can operate all locks.

The keys provided to you have been programmed to the security system on your vehicle. Any key that is not programmed to your vehicle cannot start the vehicle.

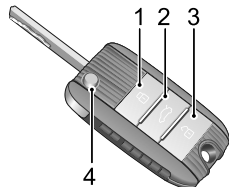

- 1 Lock Button
- 2 Tailgate Release Button
- 3 Unlock Button
- 4 Smart Key

The smart key will only work within a certain range. Its working range is sometimes influenced by the key battery condition, physical and geographical factors. For safety reasons, after locking the vehicle, check to confirm that the operation was successful.

If your key is lost/stolen or damaged, a replacement can be obtained from a MG Authorised Repairer. The lost/stolen key can be deactivated. If the lost key is found, a MG Authorised Repairer can reactivate it.

Note: *Any key made independently outside of the MG Authorised Repairer Network may not allow your car to enter READY mode, and may affect the safety of your car. To obtain a suitable key replacement, it is recommended that you can consult MG Authorised Repairer.*

Note: *The new key cannot be offered to you immediately because it requires programming to the vehicle by an MG Authorised Repairer.*

Note: *When operating the vehicle with a smart key, take care not to place the smart key close to devices with strong radio interference (electronic products*

such as notebook computers, etc.), the normal functions of the key may be affected.

STARTING & DRIVING

Replacing the Key Battery

Please use the picture guide to replace the key battery if any of the following conditions occur:

- The effective operating range of the key is significantly reduced;
- The vehicle immobilisation warning lamp on the instrument pack flashes (Refer to "Warning Lights and Indicators" in "Instruments and Controls" section).

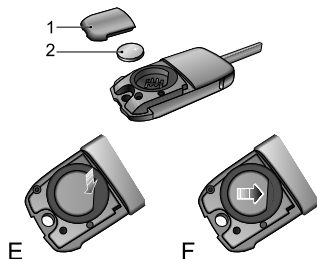
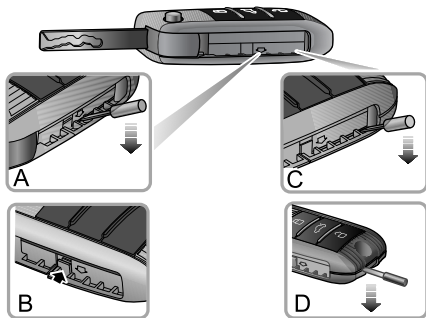

1. Unfold the remote key.
2. Insert a flat-bladed tool into position (A) shown in the figure, and apply pressure in the direction indicated by the arrow until the clip disengages (B).
3. Insert a flat-bladed tool into the position (C), and apply pressure in the direction indicated by the arrow until a gap appears at the tail end of the key.

- 4 Insert a flat-bladed tool into the gap at the tail of the key, as shown in the figure (D), slightly pry the battery cover until the two clips at the tail of battery cover disengage completely.
- 5 Carefully prise off the battery cover. (1).
- 6 Press the front part of button battery using slight force (E) to remove the battery (2).
- 7 Position the new battery, ensuring that correct polarity is maintained (“+” side facing up), slide it forward (F) ensuring it is fully inserted into the slot.

Note: *Make sure that the polarity of battery is correct (positive side upwards).*

Note: *It is recommended to use a CR2032 battery for the remote control.*

- 8 Refit the cover and press tightly. Check the gap around the cover is even.
- 9 Set the vehicle power mode to READY to resynchronize the key with the vehicle.

IMPORTANT

- Use of an incorrect or inappropriate battery may damage the remote key. The new replacement's rated voltage, sizes and specifications must be the same as the old one.
- Incorrect fitting of the battery may damage the key.
- Disposal of the used battery must be strictly in accordance with relevant environmental protection acts.

STARTING & DRIVING

Child Proof Locks



NEVER leave children unsupervised in the car.

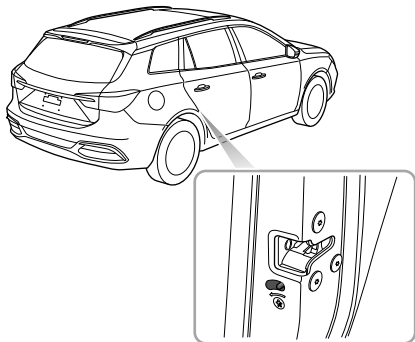

- Open the rear door at corresponding side, move the child proof lock lever to the lock position in the direction of the arrow to engage the child proof lock;
- Move the lever to the unlock position in the reverse direction of the arrow to disable the child proof lock.

With the child proof locks engaged, the rear doors cannot be opened from inside the car, but can be opened from outside the car.

Steps for enabling or disabling the child proof locks are as follows:

Anti-theft Systems

Your vehicle is fitted with an power immobiliser and a body anti-theft system. To ensure maximum safety and operation convenience, we strongly recommend you read this section carefully to fully understand the activation and deactivation of anti-theft systems.

Power Immobilisation

Power Immobilisation is designed to safeguard the vehicle from theft. The power immobilisation system can only be deactivated to start the car by using the matched key.

When the START/STOP Switch is pressed and a valid key is detected inside, the immobiliser is deactivated automatically.

If the message centre displays "Smart Key Not Detected" or "Put Key Into Back-up Position" or the power immobiliser system warning lamp illuminates, please put the smart key at the bottom of the centre console cup holder (refer to "Alternative Starting Procedure" in "Starting and Stopping the Power System" section), or try to use the spare key. If

the vehicle will still not enter READY mode, please contact an MG Authorised Repairer

STARTING & DRIVING

Body Anti-theft System

Locking and Unlocking

When the vehicle is locked, the indicator lamps flash three times; when it is unlocked, the indicator lamps flash once.

Key Locking

- Using the remote key to lock: press the lock button on the remote key to lock the vehicle after closing the doors, bonnet and tailgate.
- Using the mechanical key to lock: partially operate the door release handle, using a suitable flat blade tool, insert the tool into the underside of the trim and carefully remove the door lock trim cover, insert the key into the driver door lock and turn counterclockwise to lock the car.

Key Unlocking

- Using the remote key to unlock: press the unlock button on the key to unlock the car.
- Using the mechanical key to unlock: partially operate the door release handle, using a suitable flat blade tool, insert the tool into the underside of the trim and

carefully remove the driver door lock trim cover, insert the key into the driver door lock and turn clockwise to unlock the car.

Note: *If the vehicle power system is not switched to the ACCION/READY position within 15 seconds after the vehicle is unlocked with the mechanical key, the immobilisation alarm will be triggered.*

Note: *If no panels are opened within 30 seconds after the vehicle is unlocked by using the remote key, all doors will automatically re-lock.*

Operation of Door Lock System (Keyless) *

The keyless entry system can lock and unlock the doors and tailgate as long as you carry the smart key and approach the car.

IMPORTANT
The smart key must be within 1.5 metres of the vehicle for the keyless system to operate correctly.

Keyless Locking

After switching the vehicle power system to OFF using the START/STOP Switch and exiting the car, press the door handle button once before moving away from the car to lock all doors and tailgate (no need to press the lock button on the key). Note, this will also arm the alarm and immobilise the vehicle.

Keyless Unlocking

Press the button on the front door handle once to unlock the car, then pull the door handle to open the door.

Note: *When the vehicle is locked, if you are within the smart key range and operate the door handle button, but carry out no further action, after 30 seconds the vehicle will automatically re-lock itself to remain secure.*

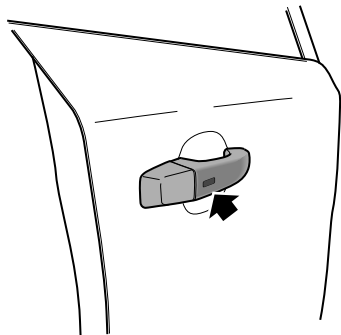

IMPORTANT

After the door is locked by using the key, press the button on the door handle to unlock the car. If the car cannot be unlocked or locked normally, seek an MG Authorised Repairer.

STARTING & DRIVING

Mislock

If the driver's door is not fully closed when the smart key lock button is pressed, or the vehicle power system has not been switched OFF, the vehicle horn will sound once, indicating a mislock. In this case, none of the doors will lock, the alarm system will not be armed and the direction indicator lights will not flash.

If the driver's door is closed, the passenger door, bonnet and tailgate are not fully closed, the horn sounds once to indicate mislock when the car undergoes locking operation. However, the 'partial arming' attributes of the security system will enable as much of the system to be armed as possible (all fully closed doors, bonnet or tailgate apertures will be protected, but an open door will not!). The alarm indicator will flash. As soon as the open aperture is closed, the system will automatically revert to an armed state

Inadvertent Locking of Keys in Vehicle

If the vehicle is locked using the mechanical key blade or handset whilst a smart key/s remain inside, the following actions will occur:

- One smart key locked in the vehicle - The immobilisation release function of the smart key locked in the vehicle is suspended, the lock and unlock function of the smart key is retained. The vehicle will not change power state. To reinstate the immobiliser release function of the smart key locked in the vehicle the second smart key should be used to unlock the vehicle. The function will automatically be reinstated.
- Both smart keys locked in vehicle - The immobilisation release function of both smart keys locked in the vehicle is suspended, the lock and unlock function of the smart keys is retained. The vehicle will not change power state. The reinstatement of key functions can only be carried out using the approved diagnostic tool. Consult an MG Authorised Repairer immediately.

Anti-Theft Alarm Sounder

If the anti-theft alarm has been triggered, the car horn will sound continuously. Press the UNLOCK button on the key, the anti-theft alarm will be deactivated.

Interior Lock and Unlock Switch

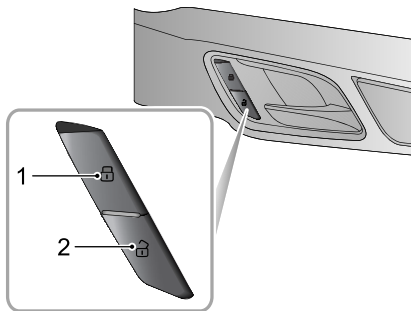

- 1 Lock Switch
- 2 Unlock Switch

When the vehicle anti-theft system is not set, press the lock switch (1) after closing all doors to lock all doors; press the unlock switch (2) to unlock all doors.

Note: If the vehicle anti-theft system is set, pressing the lock/unlock switch will not lock/unlock the doors but will trigger the alarm system.

If the doors, bonnet and tailgate are closed, press the interior lock switch, the yellow indicator on the interior lock switch illuminates.

If a mislock is caused by a non-driver door, tailgate or bonnet, press the interior lock switch, the yellow indicator on the interior lock switch illuminates.

STARTING & DRIVING

Interior Door Handles

Use the interior door handle to open the door:

- 1 Pull the interior door handle once to unlock the door.
- 2 Pull the interior door handle again to open the door.

Speed Lock

All the doors will be locked automatically when the road speed exceeds 10 mph (15 km/h).

Automatic Unlock

When the START/STOP is switched to the OFF position, all the doors will be unlocked automatically.

Tailgate

Tailgate Open Mode

The manual tailgate can be opened using the following 2 methods:

- 1 Long press the release button on the smart key (B) for more than 2 seconds to unlock the tailgate. Then the tailgate can be lifted open.
- 2 When the vehicle is unlocked, directly press the release switch (A) on the tailgate. Then the tailgate can be lifted open.

Note: *On vehicles equipped with keyless entry, if a matched key is detected within a 1m range of the tailgate press the release switch (A) on the tailgate, the tailgate can then be lifted open.*

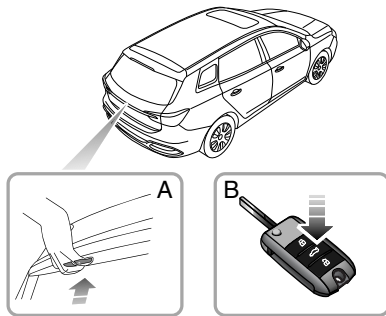

STARTING & DRIVING

Starting and Stopping the Power System

START/STOP Switch



The keyless START/STOP Switch is located in the fascia to the right of the steering column, it is a push button style switch. To operate the switch the smart key must be inside the vehicle.

The operational status displays are as follows:

Indicator Off (OFF)

If the switch has not been operated and there are no indicators illuminated, the power system is OFF. The power electric door mirrors remain operational.

Yellow Light (ACC)

Pressing the START/STOP Switch without the footbrake being applied whilst the vehicle power system is OFF will place the system in the ACC state, this will illuminate the yellow indicator in the switch button. The ACC position allows operation of certain ancillaries such as power windows.

Green Light (ON/READY)

- Whilst in the ACC state, pressing the START/STOP Switch without the footbrake being applied will place the system in the ON state, the green indicator will illuminate. This will allow some electrical systems to operate.
- Pressing the START/STOP Switch with P selected and the footbrake applied will place the vehicle in the READY state, the green indicator will illuminate. This indicates that all electrical systems will operate and the vehicle is ready to be driven.

Note: Whilst in the OFF state, if the driver exits the vehicle leaving the smart key inside, the horn will sound three times in quick succession upon closure of the driver's door. Subsequent re-opening of the driver's door will display a warning message in the instrument pack message centre to indicate that the key is still in the car.

Note: To remove the electronic shift control knob from P the vehicle must be in an ON/READY state and the footbrake applied.

If your car is subject to strong radio signals the keyless entry and start systems may suffer from interference and not function correctly. Please see the 'Alternative Starting' procedure.

READY Mode

Setting the power system into READY mode:

- 1 Ensure all unnecessary electrical loads (inc AC) are switched off .
- 2 Ensure the parking brake is applied .
- 3 Ensure P or N is selected (If the shift control knob is in any other position the power system cannot be switched to the ON/READY state).
- 4 Press brake pedal.
- 5 Press the START/STOP Switch (do not hold the button in, release immediately).
- 6 The green indicator will illuminate and READY will be displayed in the instrument pack message centre.

STARTING & DRIVING

IMPORTANT

- If the vehicle will not enter a READY state, please check for any warning indicators or messages displayed in the instrument pack message centre. In extremely low temperatures please allow 5 minutes between power up attempts, if after 3 attempts the power state cannot be set to READY please consult an MG Authorised Repairer or breakdown service.
- Do not leave the power system in an ACC or ON/READY state for long periods of time, excessive use of electrical equipment may lead to a discharged battery.
- The vehicle is fitted with an anti-theft system. Independently sourced keys may not allow vehicle entry and system power up. Any new keys will require programming using the manufacturers software.
- Your car is fitted with complex electronic control systems, please ensure that all other radio transmission or electromagnetic devices are kept away from the smart key and centre console cubby areas. They may cause interference and operational issues. Please see the 'Alternative Starting' procedure.

Alternative Starting Procedure

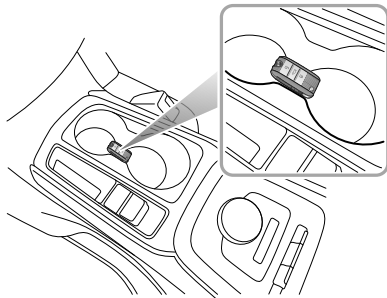

If the vehicle is located in an area where there are strong radio signals causing interference or the smart key battery condition is low, please use the following steps to attempt to start the car:

- 1 Place the smart key centrally in the centre console cup holder cubby box with the buttons facing upward - as shown in the illustration.

- 2 Ensure P or N is selected, press the brake pedal and then press START/STOP Switch to power the vehicle.

Note: *The Alternative Starting Procedure should only be required if the smart key battery is very low or flat. Once the vehicle has been removed from the area of excessive radio interference the keyless entry and START/STOP systems should return to normal.*

Switching the Power System OFF

Setting the power system to OFF:

- 1 After bringing the car to a halt, ALWAYS maintain brake pedal application.
- 2 Using the electronic shift control knob select (P) and apply the parking brake - please check that the parking brake is applied.
- 3 Press the START/STOP Switch to shut down the power system.

Note: *Please observe the park brake warning light and message displayed in the instrument pack*

message centre confirming that the parking brake is applied before exiting the vehicle.

Note: *Should the power system require to be shut down in the case of an emergency, press and hold the START/STOP Switch in excess of 4 seconds.*

STARTING & DRIVING

Pedestrian Alert Control System

In order to improve the safety, your car is fitted with a Pedestrian Alert System. When the vehicle is travelling at a low speed, the system controls a speaker that sounds to remind pedestrians in the vicinity of your presence.

Sound Strategies

The speaker sounds when all of the following conditions are met:

- 1 The vehicle is READY;
- 2 The Pedestrian Alert System is fault free;
- 3 During acceleration, the vehicle speed is above 0 mph (0 km/h) and less than 19 mph (30 km/h); during deceleration, the vehicle speed is greater than 0 mph (0 km/h) and less than, or equal to 15 mph (25 km/h).

Economical and Environmental Driving

Running-in

The brakes and tyres need time to 'bed-in' and adjust to the demands of everyday motoring. During the first 900 miles, please avoid heavy braking where possible.

Economic Driving and Maintenance

The following are some suggestions on saving power and extending the life of the vehicles.

- Maintain the correct tyre pressure; low pressures will result in accelerated tyre wear and increase power consumption.
- Do not carry unnecessary weight. Heavy loads will increase the vehicle load resulting in higher power consumption.
- Avoid continuous acceleration or deceleration. A stop-go driving style will consume more power.
- Avoid unnecessary stopping and braking, maintain a steady speed and attempt to anticipate traffic lights.

Note: Keep an appropriate distance from other vehicles to avoid emergency braking and reduce brake pad wear.

- Avoid traffic congestion and jam areas as much as possible.
- Anticipating obstructions and slowing down well in advance, avoids the need for unnecessary acceleration and harsh braking. A smooth driving style can reduce power consumption.
- Do not ride the brake pedal, this can cause premature wear, overheating and increased power consumption.
- Maintain an appropriate speed on the highway. Higher speeds use more power. Appropriate speed can save power.
- Maintain the correct wheel alignment. Avoid collisions with the kerb and reduce speed on uneven road surfaces. Out of specification wheel alignment will not only lead to excessive tyre wear, but also increases the vehicle load and power consumption.
- Avoid driving on mud or beaches. This will prevent corrosion of the vehicle underside.

STARTING & DRIVING

- Maintain the vehicle in accordance with MG recommendations. .

Note: *To extend the life of all components and reduce operating costs, regular MG Approved maintenance is needed.*

- Use of electrical equipment will reduce the power available from the battery. Whilst it is essential to maintain a comfortable interior environment, excessive use of system such as A/C will increase power consumption and reduce the vehicle range.

Driving in Special Environment

Driving in Rain or Snow



Emergency braking, accelerating and steering on slippery roads will reduce the vehicle's handling performance and grip.

- When raining the windows may fog, reducing visibility (Use the Air-conditioning demist function).
- Grip will be reduced, so please drive carefully.
- Avoid aquaplaning (the effect of a film of water between the tyres and the road) this will effect steering and braking performance.

Driving through Water

Avoid driving through floods after heavy rain, which may lead to serious damage to the vehicle.

Vehicle Control

Vehicle Control System

The vehicle control system is used to collect data regarding the requirements from the driver (accelerator pedal, brake pedal, gear shift selection etc), it uses this information to adjust the driving stability and ride comfort, and to limit the output torque of the vehicle according to the vehicle condition (practical capabilities of current high-voltage battery pack and drive motor).

Driving Mode

The driver is able to select different driving modes to suit their requirement. In different driving modes, the vehicle control system can use different control strategies for output control. For operation mode, please refer to 'Driving Mode' in 'Electric Drive Transmission' chapter.

Energy Regeneration

Whilst the vehicle is in an over-run, coasting or braking condition the vehicle will enter the KERS mode, converting part of the kinetic energy into electric energy by driving

the motor, which is then stored in the high-voltage battery pack.

The driver can choose different energy recovery levels as required. For operation mode, please refer to 'Energy Regeneration' in 'Electric Drive Transmission' chapter.

Cruise Control

The cruise control function enables the driver to keep the vehicle advancing at a constant speed without the requirement to operate the accelerator pedal. The driver can select the cruise settings by operating the lever switch. Please refer to "Cruise Control System" chapter for the operation mode.

Power Limit of Electrical Appliances

According to the current load condition and the status of the low-voltage (12V) battery, the vehicle can limit the power of some comfort electrical appliances, such as restricting partial lighting, air conditioning blower. At the same time, the prompt information will be displayed in the information centre in the instrument pack.

STARTING & DRIVING

IMPORTANT

If any of the conditions described above occur, please charge the low voltage battery as soon as possible.

Charging Requirements



Under normal circumstances it is strongly recommended that you use a slow charging method, avoid constant or regular use of rapid chargers.



Prior to using any charging equipment please inspect the sockets, plugs and cables for any damage. DO NOT use any equipment that shows signs of misuse or damage.



It is recommended that the charging cable be connected to the charging device before connecting to the vehicle and charging commences.



DO NOT attempt to switch the vehicle power system to READY during charging.



After charging completion, switch off the charger (where necessary), disconnect the cable from the vehicle, fit the waterproof blanking plugs (2 pin socket cover first), close the charging point door. If necessary you can then disconnect the cable from the charger (where applicable).



Whilst charging the car on rainy days, where possible, please avoid connecting the charger during torrential rain or storms. If excessive water is evident around the charging plugs please use a suitable cloth to dry the area as best possible before removing the waterproof blanking plugs and connecting the charging cables.



DO NOT touch the charging connector or charging plug when your hand is wet.



DO NOT stand in water or snow when connecting or disconnecting the charging cable.

STARTING & DRIVING



DO NOT attempt to charge when the charging connector and plug are wet.



Always keep the charging connector and charging plug in clean and in a dry condition. Be sure to keep the charging cable in a condition where there is no water or moisture.



Only use the correct charger for charging the electric vehicle. Using any other charger or connector configuration may cause failure.



Take care not to drop the charging connector. This could result in damage.



STOP charging immediately if you find anything abnormal, such as sparks, burning or smoke.



Always hold the charging connector handle or plug when connecting or removing the charging cable, if you pull the cable itself (without using the handle), the internal wires may disconnect or get damaged. This may lead to electric shock or fire.



High voltage charging equipment can cause interference with electronic medical devices. When using medical electrical devices such as pacemakers, please consult your doctor about whether charging your electric vehicle will impact the operation of the device. In some instances, electromagnetic waves that are generated from the charger can seriously impact medical electric device operation.



NEVER use a high powered jet wash directly on the charger door or to clean around the charge point.

Charging Your Vehicle at Home

Whilst your MG has been supplied with a home charging kit it is essential that you check with a qualified electrician that the infrastructure of your property will support the charging equipment. Please seek qualified advice that your current electrical supply and circuits will support the requirements of the charging equipment.

Installed Charging Points

Various companies will supply and install charging points to your property, MG insist that only qualified reputable suppliers and installers are used - failure to have the correct equipment installed by a qualified professional may result in overloaded circuits and fire.

Home Charging Guide

ONLY use certified approved equipment.

ONLY use qualified suppliers and installers.

When the battery is fully charged, disconnect the cable plug from the vehicle socket - if it is necessary to interrupt the charging of the vehicle, disconnect the vehicle plug first, then isolate the power supply.

NEVER allow water or fluids to enter or contaminate your charger or vehicle charging sockets.

NEVER use damaged charging points, equipment or sockets.

STOP charging immediately if you see anything unusual, smell burning or see sparks.

ALWAYS follow the operating instructions supplied with your charging equipment.

Note: *The charging point and power supply infrastructure must be installed and serviced by suitable qualified personnel from an approved installation company using only the materials recommended by them.*

STARTING & DRIVING

Charging and Medical Condition Awareness



High voltage charging equipment can create areas of strong electromagnetic interference, this may cause operational issues with electronic medical devices.

When using medical electrical devices such as pacemakers or cardioverter defibrillators (ICD's) please consult your doctor about whether charging your electric vehicle will impact on the operation of the device. In some instances, electromagnetic waves that are generated from the charger can seriously impact medical electric device operation.

Note: There are no cautions issued about medical devices when the car is not connected to a charge point and charging. It is perfectly safe for individuals fitted with pacemakers or cardioverter defibrillators to drive or ride in the vehicle.

Charging Port

The charging port is located behind the charging port door centrally mounted in the front bumper.

To open the door, ensure the vehicle is unlocked, press the MG badge and release - the door will open to reveal the waterproof plug covers.

Remove the plug covers to reveal the combined charging port.

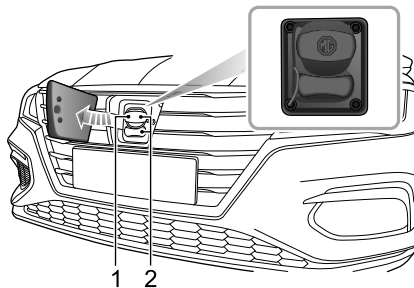

1 Slow and Fast Charge Port - 7 Pin - Type 2 Plug

2 Rapid Charge Port - 7 Pin and 2 Pin - CCS Type Plug

The upper plug covers the 7 pin slow/fast charging socket (1), the lower plug covers the rapid charging socket (2).

Note: In order to use the rapid charger socket both waterproof plug covers will require removal.

After charging, refit the waterproof plug covers (2 pin rapid charge socket cover first), close the charging port door and using the MG badge, push the door fully home until the latch locates.

ALWAYS ensure that any excess water is removed from the port area before connecting any charging device.

Charging Port Electronic Lock

In order to prevent the charging connector and cable being disconnected inadvertently during charging, the charging socket features an electronic locking mechanism.

The electronic lock is activated as soon as the vehicle is locked, and remains in a locked state until the car is unlocked.

Whilst the charging cable is connected and the vehicle locked DO NOT attempt to remove the plug.

Only when the vehicle is unlocked can the charging connector be unplugged.

Note: The car will not charge whilst in an unlocked state. During charging, if the charging port is unlocked charging will be suspended, it will reinstate when the charging port is locked again. If charging does not automatically recommence please remove and refit the charging cable.

STARTING & DRIVING

Manually Releasing the Charging Port Lock in Emergency Situations

The vehicle features an emergency release device for the charging port lock.

To access the manual release, raise the bonnet and remove the front compartment decorative cover - see picture.

Pull the release cable handle, remove the connector plug whilst maintaining tension on the cable this will release the locking device.

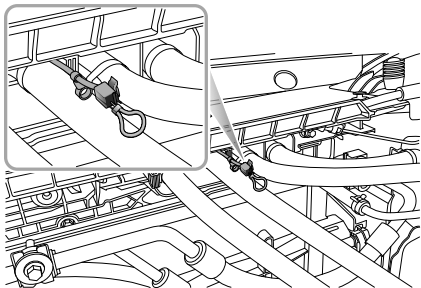

Rapid Charging

Note: Please read any equipment operating instructions carefully prior to using the rapid charging station. Each type of charger may use different instructions.

Note: The cable of the charging plug should be shorter than 30 m.

If you have any doubts please seek professional assistance.

Rapid Charging Safety Precautions

- Before connecting the rapid charger, switch the vehicle power system OFF and wait 10 seconds.

Note: If at any time during the charging process you should want to check the state of charge, please switch the vehicle power system to the ON position. The high voltage battery state of charge will be displayed in the message centre in the instrument pack.

Slow Charging

Note: Carrying out a full slow charge is the only way for the high voltage battery to reach the optimal equilibrium state (equalisation charge).

High voltage battery chargers are available with various power outputs. Chargers with outputs of up to 3 kW are generally considered as slow chargers, 7 - 22 kW are considered fast chargers and rapid chargers are available in AC or DC outputs. Generally the AC chargers are rated at 43kW and the DC chargers at 50kW plus.

Charging times are dependant on charger output.

To carry out an equalisation slow charge it is recommended that the charger output does not exceed 7kW.

STARTING & DRIVING

AC Charging Points

IMPORTANT
Please ensure that only charge points that meet IEC 61851 and IEC 62196 are used to connect to your vehicle.

Using an AC charging device:

- 1 Ensure vehicle power system is OFF and all doors are closed.
- 2 Open the charging port door, remove the waterproof plug cover from the 7 pin charging plug connector.
- 3 Plug the cable from the charger point into the vehicle. Lock the vehicle.
- 4 On completion of the charge unlock the vehicle and disconnect the plug from the vehicle.
- 5 Ensure the charge socket is free from debris, fit the waterproof plug cover. Close the charging point door.

Note: *If at any time during the charging process you should want to check the state of charge, please switch the vehicle power system to the ON position. the high*

voltage battery state of charge will be displayed in the message centre in the instrument pack.

Note: *If the vehicle is unlocked during the charging process, charging will be suspended. Charging will resume after 1 minute. If charging does not automatically resume, it may be necessary to remove and refit the charger cable.*

Residential Charging

Your vehicle will have been supplied with a residential charging device. This device can be plugged into a standard household 3 pin socket.

During the charging operation the vehicle power system must be OFF. Carry out the following procedure to charge the car using the charger supplied with the vehicle:

- 1 Ensure vehicle power system is OFF and all doors are closed.
- 2 Open the charging port door, remove the waterproof plug cover from the 7 pin charging plug connector. Ensure the surroundings are clean, dry and free from debris.
- 3 Connect the 7 pin charging plug to the socket on the vehicle.
- 4 Connect the charging device 3 pin plug to the domestic electricity supply. Lock the vehicle.
- 5 On completion of the charge unlock the vehicle, disconnect the charging cable from the vehicle, and then the domestic plug.

- 6 Ensure the charge socket is free from debris, fit the waterproof plug cover. Close the charging point door.

Note: *If at any time during the charging process you should want to check the state of charge, please switch the vehicle power system to the ON position. the high voltage battery state of charge will be displayed in the message centre in the instrument pack.*

Note: *If the vehicle is unlocked during the charging process, charging will be suspended. Charging will resume after 1 minute. If charging does not automatically resume, it may be necessary to remove and refit the charger cable.*

STARTING & DRIVING

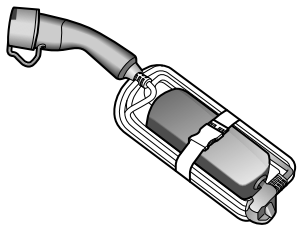

Slow charging kit (supplied with the vehicle)

Charging Information

At the beginning of the charging process, the following information will be displayed within the instrument pack message centre.

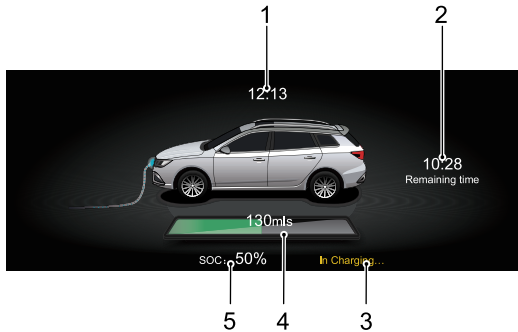

- 1 Current time
- 2 Charging time until full
- 3 Charging status
- 4 Driving range
- 5 High voltage battery pack status

STARTING & DRIVING

Equalisation Charging

Equalisation charging means that after a normal charging process the battery management system will enter a mode where it will attempt to equalise the charge of every battery cell.

If an equalisation charge has not been carried out for some time the message centre in the instrument pack will display 'Please Charge for BMS Balance'. Please refer to 'Slow Charging' in the 'Starting and Driving' section.

On average it takes at least 7.5 hours to complete a charge that includes the equalisation charge.

Note: *Ambient temperatures have an effect on charging times, it may take longer to complete a charge when the ambient temperatures are low.*

Charging Times

Charging times of the high voltage battery can vary depending upon numerous factors, these include: current capacity, charging mode, ambient temperature and device type/power.

Rapid Charging Time

Rapid chargers will vary in power output, on average it will take approximately 40 - 60 minutes to charge the high voltage battery up to 80% (80% displayed in IPK) using an average rapid charger.

Note: *Ambient temperatures have an effect on charging times, it may take longer to complete a charge when the ambient temperatures are low or high.*

Slow Charging Time

On average it takes approximately 7 hours to charge the high voltage battery from low battery warning to 100% (charge quantity can be checked using the instrument pack).

- At low temperatures the charging time will be extended.

- If an equalisation charge has not been conducted for a long time the required charge time will be extended.
- An equalisation charge must be carried out prior to using the car after a long period of storage or non use. In these cases the charging time will be extended.

Note: The slow charging notes above relate to using an AC charging device with an output rating of 7kW. Use of the slow charging device supplied with the car using a domestic power supply can increase the charging times by up to 3 times.

STARTING & DRIVING

Indicative Charging Times

Note: *These times are only a guide.*

Rapid charging		From alarm status (the high voltage battery low warning displayed in the instrument pack message centre) to 80%, it takes almost 40 minutes.		
Slow charging	Residential electricity	From alarm status (the high voltage battery low warning displayed in the instrument pack message centre) to 100% (the high voltage battery state of charge displayed in the instrument pack message centre), it takes almost 20 hours.	From alarm status (the high voltage battery low warning displayed in the instrument pack message centre) to 100% (the high voltage battery state of charge displayed in the instrument pack message centre) and equalisation, it takes almost 20.5 hours.	It takes approximately 22 hours to complete an equalisation charge for first use after the vehicle has been parked or stored for a long time.
	AC charging station	From alarm status (the high voltage battery low warning displayed in the instrument pack message centre) to 100% (the high voltage battery state of charge displayed in the instrument pack message centre), it takes almost 7 hours.	From alarm status (the high voltage battery low warning displayed in the instrument pack message centre) to 100% (the high voltage battery state of charge displayed in the instrument pack message centre) and equalisation, it takes almost 7.5 hours.	It takes approximately 9 hours to complete an equalisation charge for first use after the vehicle has been parked or stored for a long time.

Electric Drive Transmission

Instructions

The following information is very important, please read carefully before use:

- The electric drive transmission consists of a high voltage unit. **DO NOT** touch any drive components unless you have the correct training and qualifications.
- Before setting the vehicle power system to ON, please ensure that P or N is selected, the parking brake **AND** footbrake are applied.
- When the vehicle power system is **READY**, use the shift control knob to select your required gear.
- Release the parking brake but maintain footbrake application until you are ready to manoeuvre. On a flat road, once you release the footbrake you will begin to move, slowly apply the accelerator to increase your speed.

Gear Shift Control

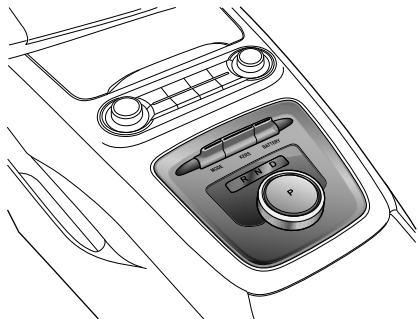

Note: The highlighted letters in the information centre indicate the selected gear or mode.

STARTING & DRIVING

Shift Control Knob Position



Do NOT turn the shift control knob to either P or R from the D position whilst driving or whilst the vehicle is in motion. This will cause severe damage to the electric drive transmission or cause an accident.

- P Park

When the shift control knob is in this position, the electronic parking brake is applied. Only select this gear when the vehicle is stationary.

Note: The electronic parking brake system must be released via the EPB switch. See “Electronic Parking Brake (EPB)” under the “Brake System” section.

Note: When the electronic parking system fails to be activated, the vehicle will enable the parking function of the electric drive transmission, the P gear indicator on the shift control knob will flash. Operating the shift control knob to select any other gear will exit Park.

- R Reverse

Select this gear only when the vehicle is stationary and you wish to drive backwards.

- N Neutral

Select this gear when the vehicle is stationary (for example, waiting for traffic lights).

- D Drive

This is used for normal driving.

Shift Control Knob Operation



DO NOT press the shift control knob whilst driving .

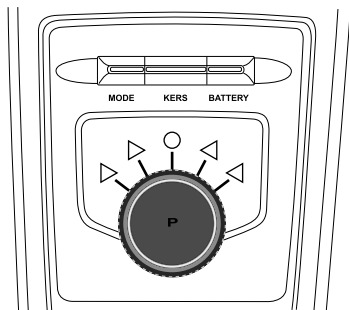

The shift control knob has 5 available positions:

The **P** position is the default and the only fixed position, any movement of the knob will return to this position.

The **▷** and **◁** positions are sprung loaded momentary positions, after selection the knob will automatically return to the central default position.

In order to prevent accidental operation by pressing the button, the shift control knob requires a firm press to

operate and select P as long as the other specific selection requirements are met.

To carry out a gear shift, operate the shift control knob as per the following instructions:

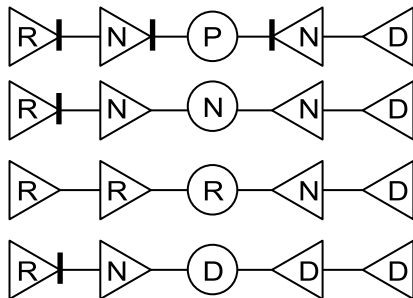

- Current gear.
- ▷ ◁ Unlocked positions.
- | Apply footbrake to allow selection.

STARTING & DRIVING

Precautions:

- The initial gear position after powering the vehicle will be P. When switching to the R, D or N positions the footbrake **MUST** be applied.
- When switching to the R position from the N position , the footbrake **MUST** be applied.
- If the vehicle speed is below 1 mph (2 km/h), the shift control knob can be pressed to select and engage P.
- If the vehicle speed is below 1 mph (2 km/h) and the START/STOP Switch is operated to power the vehicle OFF, P will automatically be selected and engaged.
- If the vehicle speed is below 1 mph (2 km/h), the footbrake released, the driver seat belt unfastened and the driver door opened, P will automatically be selected and engaged.
- For safety reasons **ALWAYS** apply the footbrake when shifting between R and D positions.

Vehicle Start-off

The vehicle can only be switched to a READY mode with P or N selected and the footbrake applied.

After selecting your desired gear position, waiting a very short time for the electrical drive transmission to engage and releasing the brake pedal, you should press the accelerator to start driving.

Driving on Hills



In cases where a short stop on a hill is required, such as a traffic jam, DO NOT momentarily apply the accelerator to prevent “roll back”. This could cause the electric drive transmission to overheat or even system damage.

Hill Start

In cases of a hill start, the start assist function of the electronic parking brake (EPB) can be used to prevent the vehicle from rolling backwards. For details of this function, please refer to “Electronic Parking Brake (EPB)” in “Brake System” section.

Models fitted with Hill Hold Control can use this function to assist hill starts. For details on hill hold control system, please refer to “Hill Hold Control System” in “Brake System” section.

Note: *The aid of these functions cannot defy the laws of physics. DO NOT drive the vehicle beyond its physical limitations, loss of control will still occur.*

Driving Mode (MODE)



Please avoid switching between Driving Modes whilst driving, this may divert the driver's attention away from road conditions and cause an accident.

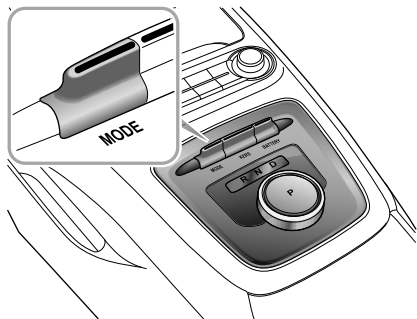

The driver can manually select three driving modes by operating the MODE switch on the centre console: Eco Mode, Normal Mode and Sport Mode.

STARTING & DRIVING

- The message centre in the instrument pack will display: E (Eco Mode), N (Normal Mode), S (Sport Mode).

Toggle the MODE switch forward or backward to switch between three driving modes.

Every time the vehicle power system is cycled and the system set to READY, the driving mode defaults to Normal Mode.

In different driving modes, the control system uses different control strategies for output control.

Eco Mode

Economy Mode optimises energy consumption, this will provide the best results regarding the range of the vehicle.

Normal Mode

Normal Mode combines economy and performance to meet the driving requirements of most drivers.

Sport Mode

Sport Mode concentrates on providing more power to enhance the performance.

Note: *Constant use of Sport Mode will decrease the range of the vehicle.*

Note: *It is recommended to choose the Sport Mode when driving in special road conditions such as mountain roads .*

Selecting different driving modes will also automatically select the settings of other systems such as electronic steering and A/C - please see the chart below:

Driving Mode	Power Mode	Steering Mode	A/C Mode	Brake Mode
Eco	Eco	Urban	Eco	Normal
Normal	Normal	Normal	Normal	Normal
Sport	Sport	Dynamic	Sport	Sport

Note: *Whilst Eco Mode is selected, the A/C will operate in a low energy consumption state to provide an increase in vehicle power.*

Energy Regeneration (KERS)



Deceleration effected by energy regeneration is NOT a substitute for braking safely. The driver must ALWAYS be prepared to make braking manoeuvres to maintain safe driving.

When the vehicle is in a braking, over-run or coasting state, the energy regeneration function is activated, and the motor converts part of the kinetic energy of the vehicle into electric energy, which is then stored in the high voltage battery.

Energy cannot be regenerated or is limited under some conditions, such as:

- N gear is selected (During driving do not coast in N gear) ;
- During torque intervention (SCS or traction control operation) ;
- High voltage battery is fully charged;
- High voltage battery temperature is too high or too low.

The energy regeneration system (KERS) has three levels:

Heavy

Heavy Level: Maximum energy is regenerated, the vehicle exhibits shorter coasting distances and a strong sensation of over-run drag or motor braking. The information centre displays ③.

Moderate

Moderate Level: moderate energy regenerated. The information centre displays ②.

Light

Light Level: Minimum energy is regenerated, the vehicle exhibits longer coasting distances and no significant sensation of over-run drag or motor braking. The information centre displays ①.

STARTING & DRIVING

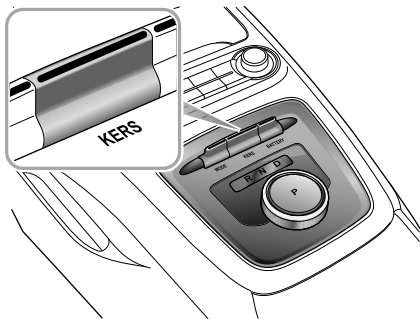

It is recommended to choose Light or Moderate levels on surfaces that have low adhesion levels (e.g. icy roads).

The driver can manually select three energy regeneration levels by operating the KERS switch in the centre console.

Toggle the KERS switch forward or backward to switch between three energy regeneration levels.



Every time the vehicle power system is cycled and the system set to READY, the energy regeneration levels defaults to Heavy Level.

Protection Mode



When parking the vehicle, please ensure the vehicle is parked safely and that all traffic by-laws are observed.

Motor Overheating Protection of Electric Drive Transmission

The electric drive transmission may become very hot in a high-temperature environment with frequent starting, frequent rapid acceleration and deceleration, long-term continuous steep climbing, and overload of the electric drive transmission. In order to prevent damage to the motor, the system will perform an overheating protection function, the warning indicator  illuminates, and the warning message “Motor Overheating” displays simultaneously. After a few seconds, the warning message will disappear but the warning indicator  will remain on.

In this case, park your vehicle safely or keeping a low load, continue to drive your vehicle at a constant speed to cool the motor. Only when the motor temperature has

decreased, the warning indicator is off, and the warning message disappears, can the vehicle be driven normally.

If the electric drive transmission has cooled down for a long time (about 20 minutes) and the warning indicator has not disappeared, please park the vehicle safely and seek an MG Authorised Repairer immediately, otherwise it may seriously damage the electric drive transmission.

IMPORTANT

When the motor of the electric drive transmission is under overheating protection, in order to avoid damage to the motor, the power of the vehicle will be limited (the information centre will display “Power Limited, Limiting Speed”, and warning indicator  will illuminate). After decelerating, the warnings will disappear when the motor temperature returns to normal.



Motor Fault of Electric Drive Transmission

If a fault or failure is detected in the motor or the power electronic box of electric drive transmission, the warning indicator  illuminates, and the warning message



STARTING & DRIVING

“Motor Fault” displays simultaneously. Please seek an MG Authorised Repairer immediately.



Parking System Fault of Electric Drive Transmission

If a fault or failure is detected in the electrical park motor control unit, the warning indicator  illuminates, and the warning message “Parking System Fault” displays simultaneously. After a few seconds, the warning message disappears but the warning indicator  will remain on, please seek an MG Authorised Repairer immediately.

Limp Mode

In some cases, when a fault or failure is detected, the electric drive transmission will enter Limp Mode and will only function at certain speeds, the warning indicator  illuminates, and the warning message “System Fault” displays simultaneously. After a few seconds, the warning message disappears but the warning indicator  will remain on, please seek an MG Authorised Repairer immediately.

Severe Functional Malfunction

In some cases, when a fault or severe failure is detected in the electric drive transmission, the warning indicator  illuminates, and the warning message “System Fault” displays simultaneously. After a few seconds, the warning message disappears but the warning indicator  will remain on. To protect the electric drive transmission, the power system will isolate the power transmission, and the vehicle cannot be driven, please seek an MG Authorised Repairer immediately.

In some cases, when a fault or severe failure is detected in the gear shift system, the information centre will display “EP”. For safety reasons, if the vehicle speed is below a preset speed, the power system will isolate the power transmission, and the vehicle cannot be driven, please seek an MG Authorised Repairer immediately.

Brake System

Foot Brake

For added safety, the hydraulic braking system operates through dual circuits. If one circuit should fail, the other will continue to function, but greater pedal pressure will be needed, brake pedal travel will increase, and longer stopping distances will be experienced. In the event of a brake failure where only one circuit is operational, the car should be brought to a halt as soon as traffic conditions safely allow. **DO NOT** continue driving - seek an MG Authorised Repairer.

Wet Conditions

Driving through water or heavy rain may adversely affect braking efficiency. In this case, keep a safe distance from other vehicles and intermittently apply the brake pedal to keep the brake disc surface dry.

Electronic Hydraulic Brake Application System (EHBS)

The vehicle is equipped with an electronic hydraulic brake application system; always be aware of the following during the operation:

- The EHBS system functions with the vehicle power system in READY mode only. Never allow the vehicle to freewheel with the power system turned off.
- If the power system should switch off or fail for any reason while driving, bring the car to a halt as quickly as traffic conditions safely allow, and depress the brake pedal with greater force. **DO NOT** continue driving - seek an MG Authorised Repairer immediately.
- If the EHBS system performance degrades due to a low battery or other reasons, you need to apply more force than usual to the brake pedal to stop the vehicle.
- If the EHBS system fails, the instrument pack message centre will illuminate the yellow warning lamp (ⓘ). At this point, the hydraulic booster compensation system starts to provide power assist, while the power assist performance is relatively low, please slow down to

STARTING & DRIVING

a stop as soon as safety permits and contact an MG Authorised Repairer as soon as possible.

Braking Response Mode

EHBS provides 2 different braking response modes:

- Standard: provides normal brake boost and brake pedal feel.
- Sport: provides extra brake boost and a more sensitive brake pedal feeling.

The user is able to select the response mode via the drive mode selection function - refer to "Electric Drive Transmission" in the "Starting and Driving" section.

Note: *If the driving mode is switched whilst driving, the braking response may not change immediately. After the vehicle comes to a halt and the brake pedal released the mode will switch automatically.*

Hydraulic Booster Compensation System (HBC)

The vehicle is equipped with an hydraulic booster compensation system. If the EHBS system fails, the HBC system begins to provide power assist. If any one of the

HBC or EHBS systems fails while the other is capable of providing power assist normally, the instrument pack message centre will illuminate the yellow lamp . At this point, the power assist performance is relatively low, please slow down to a stop as soon as safety permits and contact an MG Authorised Repairer as soon as possible.

If both the HBC and EHBS systems fail, the instrument pack message centre will illuminate the red lamp . In such a case, please stop the vehicle as soon as safety permits and contact an MG Authorised Repairer as soon as possible.

Note: *When the yellow lamp  in the instrument pack message centre illuminates and the HBC system begins to provide braking assist, a buzzing noise may be heard when pressing the brake pedal, this is normal system operation in these conditions.*

Cooperative Regenerative Braking System (CRBS)

The vehicle is equipped with a cooperative regenerative braking system, this converts the kinetic energy of the vehicle into electric energy while braking and stores the energy in the HV battery, so as to prolong the driving range.

Note: *When the cooperative regenerative braking energy function is triggered, the driver may hear a small motor operational noise and feel a slight vibration on the brake pedal at low road speeds. This is a normal sensation when the system is triggered.*

Electronic Brake Force Distribution (EBD)

The vehicle is equipped with EBD, which, in order to maintain braking efficiency, distributes braking forces between front and rear wheels, under all load conditions.

EBD integrates a monitoring system. The monitoring system is linked to the brake system malfunction indicator lamp on the instrument pack. Refer to "Warning Lights and Indicators" in "Instruments and Controls" section.

If the indicator lamp illuminates while driving, or remains illuminated after the START/STOP Switch is turned on (ON/READY position), it indicates there is a failure with the braking system, and EBD may be inoperative. In such a case, stop the car as soon as safety permits and seek an MG Authorised Repairer immediately. DO NOT drive the car with the brake system malfunction indicator lamp illuminated.

Electronic Brake Assistance (EBA)

The vehicle is equipped with Electronic Brake Assistance (EBA). When the brake pedal is applied for emergency braking, EBA system will help the driver increase the braking force acted on each wheel to reach the working point of ABS, thereby shortening the braking distance.

STARTING & DRIVING

Anti-lock Brake System (ABS)



ABS cannot overcome the physical limitations of stopping the car in too short a distance, running at too high a speed, or in danger of aquaplaning, i.e. where a layer of water prevents adequate contact between the tyres and the road surface.

The purpose of the anti-lock brake system ABS is to prevent the wheels from locking while braking, thereby enabling the driver to retain steering control of the car.

The fact that a car is fitted with ABS must never tempt the driver into taking risks that could affect his/her safety or that of other road users. In all cases, it remains the driver's responsibility to drive within normal safety margins, having due consideration for prevailing weather and traffic conditions.

Under normal braking conditions, ABS will not be activated. However, once the braking force exceeds the available adhesion between the tyres and the road surface, thereby causing the wheels to lock, ABS will automatically

come into operation. This will be recognisable by a rapid pulsation felt through the brake pedal.

Braking in an Emergency



DO NOT pump the brake pedal at any time; this will interrupt the operation of ABS and may increase the braking distance.

If an emergency situation occurs, the driver should apply full braking effort even when the road surface is slippery. ABS will ensure that the wheels do not lock and that the car is brought to a halt in the shortest possible distance for the prevailing road surface conditions.

Note: On soft surfaces such as powdery snow, sand or gravel, the braking distance produced by the ABS system may be greater than that for a non-ABS system, even improved steering would be experienced. This is because the natural action of locked wheels on soft surfaces is to build up a wedge of material in front of the tyre contact patch. This effect assists the car in stopping.

No matter how hard you brake, you are still able to continue steering the vehicle as normal.

IMPORTANT

ABS can not reliably make up for the driver's mis-operation or lack of experience.

ABS Malfunction Indicator Lamp

Refer to "Warning Lights and Indicators" in "Instruments and Controls" section.

Note: *The normal (non-ABS) braking system remains fully operational and is not affected by partial or full loss of ABS. However, the braking distances may increase.*

Hill Hold Control (HHC)



HHC has limitations when subject to adverse conditions such as wet or icy surfaces and steep slopes. The driver must always maintain control of the vehicle and attention should not be reduced just because HHC is enabled.



HHC is not a substitute for parking brake application when carrying out a hill start. DO NOT exit the vehicle with only HHC applied, it may lead to a serious accident when HHC releases.



The car may roll if 'pull-away' is not achieved immediately after releasing the brake pedal. Always ensure the brake pedal is pressed or electronic parking brake applied until drive is taken up.



Firm application of the brake pedal when stopping is required by HHC to generate sufficient brake pressure to maintain hold.

STARTING & DRIVING

Hill Hold Control is a comfort function. It works on inclines when the car detects it has come to a 'stand still status'. It assists the driver by 'holding' the vehicle during hill starts.

The following conditions must be fulfilled to activate HHC:

- The driver's door is closed and the driver seat belt is fastened.
- The vehicle is stopped on a slope in excess of 4%.
- SCS is active and fault free.
- EPB is released and fault free.
- In D or R gear.
- Power system is READY/RUNNING.
- Sufficient brake pedal application force has been applied.

As long as D or R is selected and the brake pedal released, the vehicle will maintain pressure in the braking system for 1 ~ 2 seconds. After this, the Hill Hold will release.

If the driver releases the brake pedal on a hill, HHC will maintain brake pressure for 1 ~ 2 seconds, after this period the vehicle may roll backwards.

Note: When the HHC system is operating to keep the vehicle still, even if the driver releases the brake

pedal, the pedal will not return to its initial position, it will remain in the pressed position. When the brake is released, the brake pedal will return to its initial position.

Note: HHC is available in both forward and backward directions when pulling away on uphill slopes.

Note: If "Hill Hold Unavailable" is displayed in the information message centre it indicates that the system has detected a fault or another system may be preventing correct operation. Please contact an MG Authorised Repairer as soon as possible.

Auto Hold



When auto hold stops the vehicle for reasons such as power system shutdown, releasing the seat belt or pressing the auto hold switch, the electronic parking brake is applied. It cannot be guaranteed that the vehicle will be stabilised in all cases. For example, the rear wheels are on a slippery road surface, or the vehicle incline is too great (larger than 20%). Please make sure that the vehicle is safely stabilised prior to exiting.



DO NOT take any extra risks when driving due to the fact the vehicle is fitted with additional convenience functions. The driver should pay full attention and observe the surroundings even if the vehicle is equipped with auto hold system.



The auto hold function cannot guarantee the stability of the vehicle when starting off or braking on hills especially on slippery or icy surfaces.



DO NOT leave the vehicle when the power system is operating and the auto hold is active.



Auto hold cannot guarantee the electronic parking brake operation in all cases where the power system is turned off. Please ensure the electronic parking brake is applied and the vehicle is stabilised prior to exiting the vehicle.



The auto hold function should be switched off during the use of automatic car washes, the electronic parking brake may suddenly apply and cause vehicle damage.

With the power system active, if the vehicle is required to stop frequently for a length of time (such as traffic lights, traffic queues or stop/start), the auto hold system assists in stabilising the vehicle, enabling you to remove your foot from the brake pedal when the vehicle is stationary and the Auto Hold active.

Auto hold has 3 main states:

- I Off: Function in Off state.

STARTING & DRIVING

- 2 Standby: Function in Standby state; the function is activated but the vehicle is not parked. Once the vehicle has stopped, and all other conditions are met, the system will automatically select Park.
- 3 Parking: Function in Parked state. In this state the green lamp (P) in the instrument pack illuminates.

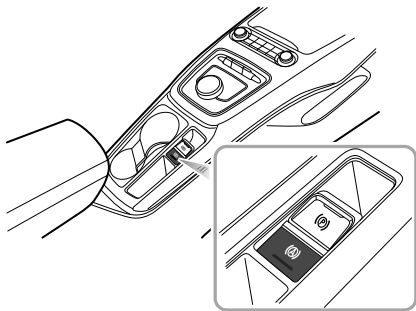

With the driver's seat belt fastened, the door closed and the power system operating, press the auto hold switch to switch the auto hold function from Off to Standby state.

With the brake pedal firmly pressed and the vehicle completely stopped, the auto hold function will switch from the Standby state to the Parking state.

When the auto hold is in the Parking state, engaging D or R and pressing the accelerator will automatically release the auto hold function.

In some circumstances such as releasing the seat belt, switching off the power system or remaining static for a length of time it will result in the vehicle exiting the auto hold Parking state. At this time the electronic parking brake will remain applied and will require the driver to release it using the switch.

Note: *When the auto hold is in the parking state, even if the driver releases the brake pedal, the pedal will not return to its initial position, it will remain in the pressed position. When the auto hold automatically releases or exiting the parking state and enabling the EPB, the brake pedal will return to its initial position.*

Note: With the brake pedal pressed, operating the switch to turn the auto hold off, the system will **NOT** apply the parking brake.

Note: It is recommended to turn off the auto hold function when reversing into the garage.

Emergency Braking Hazard Warning Lights Control System (HAZ)

If the vehicle is travelling at high speed and the driver makes an emergency braking manoeuvre, the system will automatically flash the brake lamps to warn the following drivers, thereby effectively reducing the risk of rear-end collision accidents.

Note: If the hazard warning lights are being operated manually, this suspends the HAZ function.

When the emergency braking manoeuvre is exited (no severe deceleration detected) then the function will be switched off after a few seconds.

Electronic Parking Brake (EPB)



In the event of EPB malfunction where EPB release is not possible, please consult an MG Authorised Repairer in order to carry out an emergency manual release of the parking brake.

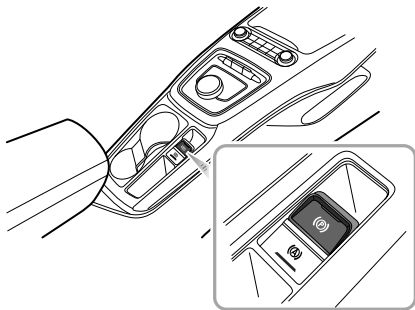

STARTING & DRIVING

Applying the EPB

When the vehicle is parked safely, selecting P on the gear shift control knob will automatically apply the EPB. If automatic application of the EPB fails, it is necessary to manually apply the parking brake using the EPB switch

- Pull the EPB switch upward until the indicator in the EPB switch illuminates.
- If the indicator lamp in the EPB switch and the indicator lamp (P) in the instrument pack illuminate, it indicates that the EPB is applied.
- If the EPB MIL (P) in the instrument pack stays on, it indicates that the EPB has a fault. Please contact an MG Authorised Repairer immediately.

Note: *An audible motor noise may be heard when applying or releasing the EPB.*

IMPORTANT

- DO NOT leave the vehicle before the indicator in EPB switch illuminates and the gear indicator displays P, the vehicle may not be safely parked due to EPB failure and slip.
- In the event of a flat battery or power failure it is not possible to apply or release the EPB. If using 'jump leads' to temporarily supply power please see 'Emergency Starting' in the Emergency Information.

Releasing the EPB

If the vehicle is stably parked on a flat road or slight incline/decline, the vehicle power system is READY, press the brake pedal and use the shift control system to switch from P to N, D or R, the EPB will automatically released.

If on a steep slope, switching from the P position will not automatically release the EPB. In this case, manually release the EPB as follows or apply the start assist function of the EPB to release the EPB.

- Place the START/STOP Switch in the ON/READY position, press the brake pedal, and press the EPB switch;
- The indicator in the EPB switch and the indicator lamp (P) in the instrument pack are extinguished, the EPB is released.

Start Assist

The EPB can predict the driver's intention and automatically release the EPB.

If the driver's seat belt is fastened, the power system is READY, D or R gear is selected and the accelerator pedal is pressed in order to pull away, the EPB will automatically release.

Emergency Braking Function



Inappropriate use of the EPB can lead to accidents and injuries. Do not apply the EPB for vehicle braking, unless in emergency.



During emergency braking using the EPB, DO NOT switch off the vehicle power system, this could result in serious injury.

In the event of normal brake failure, emergency braking using the EPB can be initiated by pulling and holding the EPB switch upward.

- Pulling and holding the EPB switch upward can realize emergency braking. During emergency braking using EPB, an audible warning will sound.
- To cancel the emergency braking process, release the EPB switch.

STARTING & DRIVING

Stability Control System (SCS) and Traction Control System (TCS)

Stability Control System (SCS)

SCS is designed to assist the driver in control of driving direction. The SCS automatically enters Standby mode after the power system is started.

When SCS detects that the vehicle is not moving in the intended direction, it will intervene by applying brake force to selected wheels or through the power management system to prevent sliding and assist in bringing the car back to the right direction.

Traction Control System (TCS)

The purpose of TCS is to aid traction and driving stability, thereby helping the driver to maintain control of the car. TCS monitors the driving speed of each wheel individually. If spin is detected on one wheel, the system automatically brakes that wheel, transferring torque to the opposite, non-spinning wheel. If both wheels are spinning, the system will reduce the output torque of the power system in order to regulate wheel rotation until traction is regained.

Switching On/Off

SCS and TCS are automatically switched on when the START/STOP Switch placed in the ON/READY position. They can be switched off by using the "Stability Control" switch located within the infotainment system display.

When SCS and TCS are switched off, Stability Control/Traction Control System OFF Warning Lamps in the message centre of instrument pack will illuminate. Refer to "Warning Lights and Indicators" in "Instruments and Controls" section.

Note: *Disabling SCS and TCS will not affect the operation of ABS. Always disable SCS and TCS when driving with snow chains fitted.*

Stability Control/Traction Control Warning Lamps

Refer to "Warning Lights and Indicators" in "Instruments and Controls" section.

Tyre Pressure Monitoring System (TPMS)



TPMS cannot replace routine maintenance and check of the tyre condition or pressure.



Using equipment that transmits on frequencies similar to that of the TPMS may interfere with the operation of the Tyre Pressure Monitoring System, this may illuminate a warning or register a temporary fault.

Note: *TPMS only gives the driver a warning when the tyre pressure is low, it will not inflate the tyre.*

TPMS uses pressure sensors built into tyre valves to continuously monitor pressure and transmits signal to ECU inside the vehicle using RF signals. If it deduces that the pressure of that tyre has fallen below the predefined limit of the system, the warning light on the instrument pack will illuminate (always yellow). For more information, please refer to 'Instrument Pack' in 'Instruments and Controls'

section. Check your tyres at the earliest opportunity and reinflate to the correct pressure. Please refer to 'Tyre Pressure (Cold)' in 'Technical Data' section.

System Malfunction



This system is self-monitoring, if a malfunction is detected, the TPMS warning lamp (yellow) on the instrument pack will flash for 90 seconds first and then remain illuminated.

Note: *When a puncture is detected, the system will require some time to analyse information prior to illuminating the warning lamp.*

Under certain conditions the warning light may illuminate when a fault is not present, these conditions include:

- A non recommended tyre fitted (including spare tyre).
- Rough terrain driving for excessive periods.
- Bending or mountain type terrain driving for excessive periods.
- TPMS will not respond immediately if a tyre 'blows out'.

STARTING & DRIVING

TPMS Self-learning

The TPMS system is a 'self learning' system, after resetting tyre pressures it will be necessary to allow the system to go through a self learning process. This is done by driving the car, during this process the system is suspended and the data displayed may not be correct. If sensors or receiver module are replaced the system requires programming, consult an MG Authorised Repairer. If the wheels are swapped or rotated the system requires reprogramming to learn the new transmitter positions, consult an MG Authorised Repairer.

Cruise Control System *

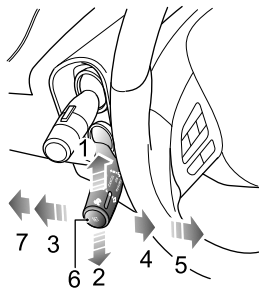



- Acceleration (1)
- Deceleration (2)
- Cruise Cancel (3)
- Cruise On/Standby (4)
- Cruise Resume (5)
- Cruise Set (6)
- Cruise OFF (7)

Cruise control enables the driver to maintain a constant road speed without using the accelerator pedal. This is particularly useful for motorway cruising, or for any

journey where a constant speed can be maintained for a lengthy period.

Cruise Control System Activation

Cruise control system is operated with a lever located at the left side of the steering wheel underneath the lighting stalk switch.

- 1 With the START/STOP Switch in the ON/READY position, if the lever switch is in the 'OFF' position (7), then the cruise control is OFF. If the lever switch is in the 'ON' position (4), then the system is in standby. Pull the lever switch to the 'ON' position (4), the yellow indicator lamp  in the instrument pack illuminates, indicating the system is in 'standby' mode.
- 2 With the system in 'Standby', when the current vehicle speed is above 20 mph (30 km/h), press the 'Set' button (6) at the end of the lever switch. The yellow indicator lamp  in the instrument pack will change to green and the system will enter the activated state. The target speed of the cruise system will be set at the current speed, and the cruise system will take effect. At this time, the cruise control system will maintain

STARTING & DRIVING

the set speed without pressing the accelerator pedal. The operating range of the cruise control system is 20 - 100 mph (30 - 160 km/h).

Note: *The set speed held in the cruise control memory will be cancelled when either the cruise control lever is switched to 'OFF' position (7) or the START/STOP Switch turned off.*

Target Cruise Speed Adjustment

When the cruise control is active:

Push the lever upwards (1) and hold, this will increase the speed. Release the lever switch when the desired speed is reached.

Push the lever downwards (2) and hold, this will decrease the speed. Release the lever switch when the desired speed is reached.

Push the lever switch upwards (1) or downwards (2) briefly to increase or decrease the vehicle target speed in increments of 1 mph (1 km/h), the vehicle will accelerate/decelerate to the new target speed.

Pressing the accelerator at any time will override the cruise control and allow acceleration to undertake manoeuvres such as overtaking. Releasing the accelerator will return the vehicle to the set target speed.

Pause/Standby

Cruise control will be disengaged and set to 'Standby' if:

- Lever switch moved to 'Cancel' position (3).
- Brake pedal pressed.
- Shift Control Knob moved to P, R or N.
- Conditions initiate SCS intervention.
- An incline causes excessive decline in speed.
- The EPB button is operated.

Resume

If the cruise control remains on after disengagement, moving the lever switch to the 'Resume' position (5) will reinstate the target speed to the setting prior to disengagement.

Note:

- **Never use the cruise control system in reverse gear.**

- **DO NOT** use the cruise control in unsuitable conditions, such as on slippery surfaces, excessively heavy rain or in traffic conditions that do not suit maintenance of constant speeds.
- When not in use, ensure the lever switch is in the 'OFF' position (7).
- When the electric drive transmission is in 'Sport' mode, it is not recommended to use the cruise control system.
- During the operation of the cruise control system, the actual speed may deviate from the target cruise speed to some extent due to road conditions (such as uphill, downhill, etc.).
- If the actual speed is excessively lower than the target speed or SCS is activated due to the hill or road surfaces, the cruise control system may automatically revert to Standby mode.
- **DO NOT** operate the switch for excessively long periods, or press multiple switches simultaneously, this may cause the system to fail. If this situation occurs, when it is safe to do so, cycle the vehicle power system.

STARTING & DRIVING

Parking Aid

Ultrasonic Sensor Parking Aid



The purpose of the parking aid is to assist the driver in reversing! The sensors may not be able to detect certain types of obstruction, e.g. narrow posts or small objects no more than a few inches wide, small objects close to the ground, objects above the tail gate and some objects with nonreflective surfaces.



Keep the sensors free from dirt, ice and snow. If deposits build up on the surface of the sensors, their performance may be impaired. When washing the car, avoid aiming high pressure water jets directly at the sensors from close range.

Rear Parking Aid

The ultrasonic sensors in the rear bumper monitor the area behind the vehicle to search for obstacles. If an obstruction is detected, the system calculates its distance from the rear of the car and communicates this information to the driver by sound warning chimes.

Parking Aid Operation

When the START/STOP Switch is in the ON/READY position, the rear parking aid is enabled automatically when reverse gear is selected, it is switched off as soon as reverse gear is disengaged. A short beep is given by the parking aid within 1 second after selecting reverse gear to indicate that the system is operating normally.

Note: *If a longer, higher pitched sound is emitted for 3 seconds when reverse gear is selected, this indicates a fault in the system. In this case seek assistance from your MG Authorised Repairer.*

With the parking aid function enabled, if an obstruction is detected, the audible sounds in different frequencies are transmitted (there might be blind zones).

- If an obstruction is located within 1.2m range of the rear parking aid sensors, the warning commences. As the car moves closer to the obstruction, the audible sounds are transmitted more rapidly.
- Once the obstruction is within 30cm range of the rear bumper, the audible sounds will merge into a continuous warning.

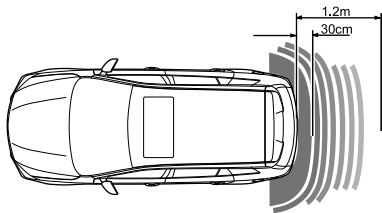

Parking Camera



The purpose of the parking camera system is to assist the driver in reversing! The camera has limited field of view and cannot detect obstructions outside the field of view.

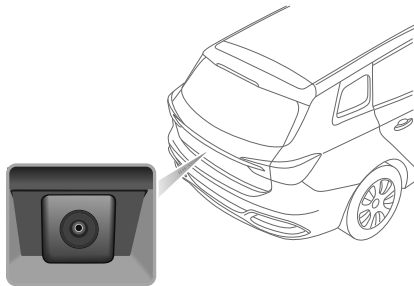

A rear parking camera is fitted between the license plate lamps. When reverse gear is selected, the camera will

STARTING & DRIVING

display an image of what is immediately behind the car. This image will be shown on the entertainment system screen.

Models fitted with the parking camera system display an overlay grid on the camera image in the entertainment display to assist parking, this is supported by the silhouette image showing object distance from each sensor.

Load Carrying



DO NOT exceed the gross vehicle weight or the permitted front and rear axle loads. Failure may result in vehicle damage or serious injury.

Loadspace Loading



Ensure that the rear seat backrests are securely latched in the upright position when loads are carried in the load space behind the seats.

When luggage is carried in the load space, always ensure heavy items are placed as low and as far forward as possible, so as to avoid the cargo shift in the event of an accident or sudden stop.

Drive carefully and avoid emergency braking or manoeuvres.

Driving with the tailgate open is very dangerous. If the load being carried requires the tailgate to be open, please ensure the cargo is suitably secured.

IMPORTANT

Traffic regulations must be observed when loading cargo, if the cargo extrudes the loadspace appropriate warning measures must be taken to warn other road users.

Internal Loading



DO NOT carry unsecured equipment, tools or luggage that could move, causing personal injury in the event of an accident, or emergency braking or hard acceleration.



DO NOT obstruct the driver's or passenger's vision with loads.

Folding the rear seats can increase luggage space, refer to "Rear Seats" described in the "Seats and Restraints" section.

When cargo is loaded in the vehicle, place it at a position as low as possible and ensure that it is tightly secured, so as to avoid personal injury caused by cargo movement when traffic accidents or emergency braking occurs. If the cargo

STARTING & DRIVING

has to be placed on a seat, then the seat must not be used by an occupant during that time.

Emergency Information

184 Hazard Warning Devices

185 eCall - SOS Emergency Assistance

187 Emergency Starting

190 Vehicle Recovery

*194 Tyre Repair and Wheel
Replacement*

201 Fuse Replacement

209 Bulb Replacement

EMERGENCY INFORMATION

Hazard Warning Devices

Hazard Warning Lights

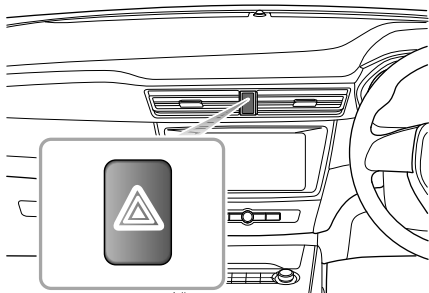

Note: Before you stop or slow the car in an emergency, always press the hazard warning switch. All the direction indicators will flash together to warn other road users when your car is causing an obstruction or is in a hazardous situation. Remember to switch off before driving away.

Warning Triangle

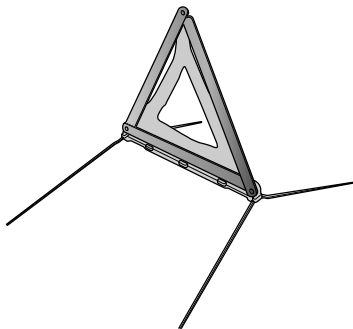

The warning triangle supplied with your car is stowed in the loadspace.

If you have to stop your car on the road in an emergency, you must place a warning triangle approximately 50 - 150 metres behind the car, if possible, to warn other road users of your position.

eCall - SOS Emergency Assistance

In an accident, your vehicle's eCall – SOS Emergency Assistance can either be triggered manually or in severe cases automatically upon detection by vehicle sensors. The eCall service is a public service and is accessible free of charge. The emergency call centre will establish verbal communication with the vehicle occupants in order to understand the extent of the emergency and the level of assistance required. If verbal communication is not achievable an attempt will be made to send the following vehicle information to the emergency call centre. The appropriate emergency services will be deployed to the vehicle's current location if known.

- Current time, location and direction of travel
- Vehicle type
- Vehicle identification number (VIN)
- Whether the call was automatically or manually initiated
- Vehicle category

This system will ensure that your personal data is securely protected. It is designed to ensure that it is not traceable and other external systems are not available. When the

eCall triggers, the system will only transmit the data information to the relevant public safety answering points designated by the respective public authorities of the country on which territory they are located, which will receive and process your emergency call request. The system will retain data locally for 13 hours after triggering.

You have the right to access the data information stored in this system, and to request the rectification, erasure or blocking of data information that does not meet the requirements of the regulations. When you think your personal data is infringed, you have the right to complain to the competent data protection authority.

For manual activation, press and release the SOS button in the overhead console for 1 second to activate an emergency services call. A single beep will be heard when the eCall is triggered and a message will be displayed on the vehicle's message centre and entertainment player. The entertainment player will be muted whilst the emergency services call is active. Manually triggered emergency service calls may be cancelled by pressing and releasing the SOS button again within 5 seconds of the initial press, two beeps will be heard confirming that the emergency

EMERGENCY INFORMATION

services call has been cancelled and the messages will be removed.

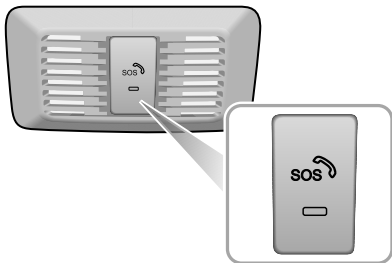

The emergency services call (eCall) system will perform a self-test when the vehicle power system is ON. During a Self-Test the emergency services call (eCall) LED status indicator on the SOS button will flash quickly until completion. The LED status indicator will be illuminated solid if no system faults are present. The LED status indicator will not illuminate or flash slowly if a fault is

detected. Faults detected during the self-test will be displayed on the vehicles message centre.

Note: *The operation of eCall - SOS Emergency Assistance relies on cellular coverage and may be affected by signal outages or low signal strength.*

Note: *The automatic emergency services call (eCall) function may be disabled by the local MG Authorised Repairer upon request.*

Emergency Starting

Using Booster Cables

! NEVER attempt to power the vehicle by pushing or towing.

! Make sure that both batteries are of the same rated voltage (12 volts), and that the booster cables are approved for use with 12 volt car batteries.

! Ensure sparks and naked flames are kept well away from the front compartment.

Using booster cables (jump leads) from a donor battery, or a battery fitted to a donor vehicle, is the only approved method of powering a car with a flat battery.

If the battery from a donor vehicle is to be used, make sure that the vehicles are parked so that the two batteries are adjacent to one another and that both the vehicles do not touch.

Starting the Car



Ensure that each booster cable connection is securely made. There must be no risk of the clips accidentally slipping from the battery terminals, this could cause sparking, which could lead to fire or explosion.

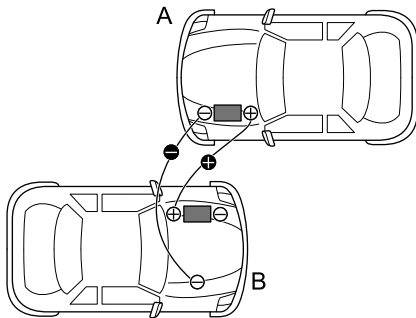

EMERGENCY INFORMATION

Ensure the START/STOP Switch is turned off and switch off ALL electrical equipment of BOTH vehicles, then follow the instructions below:

- 1 Connect the RED booster cable between the positive (+) terminals of both batteries. Connect the BLACK booster cable from the negative (-) terminal of the donor battery (A) to a good earth point (the CCU mounting or other unpainted surface, for example), as far away from the battery as possible and well away from brake lines on the disabled vehicle (B).

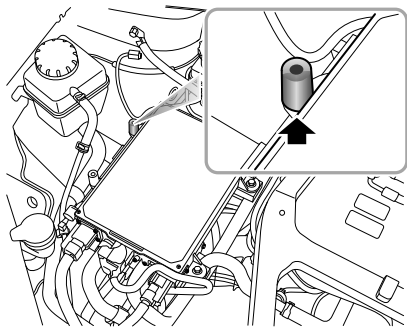

- 2 Start the donor vehicle and allow it to run for a few minutes.
- 3 Now switch the vehicle power system of the vehicle with the discharged battery to READY. If the disabled vehicle will not switch to READY it may need to be repaired. Please contact an MG Authorised Repairer.
- 4 After both the vehicles have normally started/powerd, leave the vehicles connected in this

state for more than 2 minutes before switch off the donor vehicle and disconnecting the booster cables.

IMPORTANT

DO NOT switch on any electrical appliance in the disabled vehicle until the booster cables have been disconnected.

- 5 Disconnecting the booster cables must be an exact reversal of the procedure used to connect them, i.e. disconnect the BLACK cable from the earth point on the disabled vehicle FIRST.

Note: *It is recommended to ensure that the disabled vehicle remains powered or runs for more than 1 hour after it is started, in order to recover the battery power.*

EMERGENCY INFORMATION

Vehicle Recovery

Towing Vehicle



When pushing or towing the vehicle onto the transporter, the speed must remain below 3mph (5km/h) and be completed within 3 minutes.



When pushing or towing the vehicle onto the transporter, the driver's side seat belt should be inserted into the lock and maintained in the inserted state in order to release the EPB.

Towing Hook



DO NOT use a tow rope that is twisted - or the towing hook may be unscrewed.



DO NOT tow the vehicle with the driven front wheels in contact with the road surface.

EMERGENCY INFORMATION

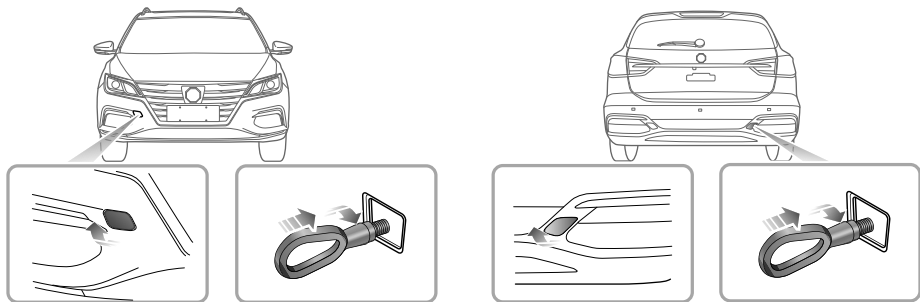

5

Your car is equipped with 2 towing eyes (located at the front and the rear of the vehicle), which are used for fitting the towing hook in the tool kit. The tool kit is placed beneath the loadspace floor.

To fit the towing hook, remove the small cover set into the bumper, then screw the towing hook via the small hole into the threaded hole in the bumper beam (see illustration). Ensure the towing hook is fully tightened!

Note: *The towing eye cover may be secured to the bumper by a plastic cord.*

Both towing points are intended for use by qualified recovery specialists to assist in the recovery of your car when a breakdown or accident occur. They are not designed for towing other vehicles, and must NEVER be used to tow a trailer or caravan.

EMERGENCY INFORMATION

Towing for Recovery



If, due to an electrical fault, potential safety hazards may exist, please ensure the vehicle power system is switched OFF.



When towing, DO NOT accelerate or brake suddenly, this can cause accidents.



DO NOT tow the vehicle with all 4 wheels in contact with the road, this will cause damage to the electric drive transmission.

Suspended Towing



When using suspended towing, be careful not to let the high voltage battery pack touch the ground.

Suspended towing is the best method for a vehicle that needs to be towed. The driven wheels **MUST** be suspended above the ground, this is to avoid any damage to electric drive transmission and possible inadvertent powering of

the vehicle. Ensure the EPB is released, the hazard lamps are ON and no passengers are in the vehicle.

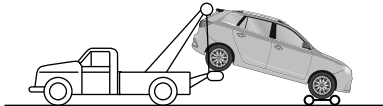
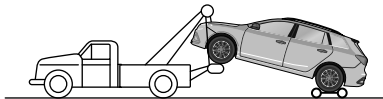
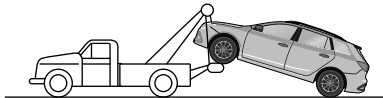

Transporter or Trailer with Rope

If your car is to be transported on the back of a trailer or transporter, it must be secured as illustrated:

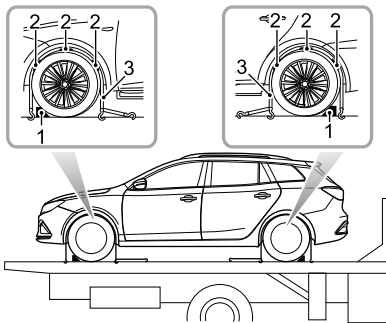

- 1 Apply the parking brake and place the electric drive transmission in park.
- 2 Fit wheel chocks (1) as shown, then position the anti slip rubber blocks (2) around the circumference of the tyre.

- 3 Fit the lashing straps (3) around the wheels and secure to the trailer. Tighten the straps until the car is securely held.

EMERGENCY INFORMATION

Tyre Repair and Wheel Replacement

Tool Identification

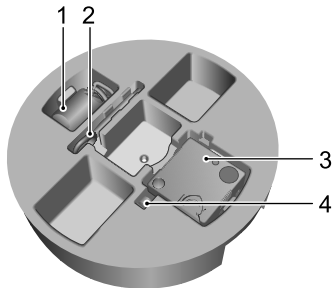

- 1 Repair Fluid Reservoir
- 2 Towing Hook
- 3 Electric Air Pump
- 4 Wheel Bolt Cap Removal Tool

Tyre Repair

- 1 Remove the label at the bottom of the repair fluid reservoir and attach it to the steering wheel to remind the driver not to exceed 50 mph (80 km/h).

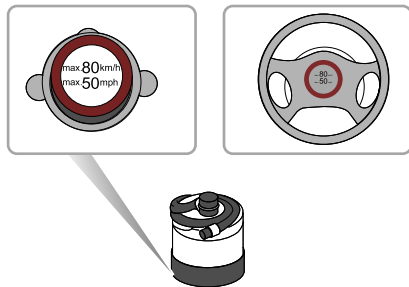

- 2 Connect the air hose of the electric air pump to the repair fluid reservoir, fit the tyre sealant bottle (upright) into the slot on the compressor. Remove the valve dust cap of the flat tyre, and connect the filler hose from the tyre sealant bottle to the tyre

EMERGENCY INFORMATION

valve. Ensure that the power switch of the electric air compressor is switched off (i.e., press “O”), then insert the plug from the compressor into the centre console power socket, and turn the vehicle power system to ON/READY.



Note: To avoid battery discharge, it is recommended to keep the vehicle in P and READY mode.

- 3 Switch on the power switch of the electric compressor (i.e., press “-”), to start pumping sealant into the tyre. The tyre sealant bottle will become empty after approximately 30 seconds. The tyre should reach the specified pressure within 5 or 10 minutes.

Note: The pressure gauge may briefly reach 6 bar (87 psi), then the pressure begins to drop to normal.

- 4 When the required pressure is reached, switch off the power switch of the electric compressor (i.e., press “O”).

Note: If the required pressure cannot be reached within 10 minutes, please disconnect the compressor, drive the vehicle 10 metres (33 feet) approx forward or backward to allow the sealant to spread within the tyre. If the required pressure can still not be reached, the tyre is severely damaged and you should seek assistance from the MG Authorised Repairer.

EMERGENCY INFORMATION

Note: *Consecutive operation of Electric air compressor for more than 10 minutes may result in damage to the compressor.*

Note: *Under no circumstances should you continue your journey with a deflated tyre. Driving a vehicle with a deflated tyre is extremely dangerous.*

- 5 Remove the tyre sealant bottle from the slot in the compressor, disconnect the hose from the tyre valve, remove the compressor plug from the centre console power socket, return the tyre repair kit to its stowage tray.
- 6 Please drive the vehicle within one minute after completing the above operations, so that the sealant is evenly distributed in the tyre. Please **DO NOT** drive exceed 50 mph (80 km/h).

Please take different measures based on the tyre pressure measured:

If the tyre pressure has dropped to less than 0.8 bar (11.6 psi), do not continue driving, seek assistance instead.

If the tyre pressure is between 0.8 bar (11.6 psi) and specified pressure, connect the hose of electric air pump to the tyre valve, and connect the plug of the electric air pump to the power socket, then switch on the electric air pump to inflate the tyre until it reaches the specified pressure. Repeat the operations of step 6 after driving a maximum distance of 3 miles (5 km).



If the tyre pressure has not dropped, you may continue driving, but the vehicle speed must not exceed 50 mph

EMERGENCY INFORMATION

(80 km/h), and the driving mileage must not exceed 125 miles (200 km).

Note: *DO NOT* remove foreign objects (eg. screws,nails) from the tyre. The tyre repair system must only be used when the foreign object is in the tread pattern (A), *DO NOT* attempt a repair when the damage is in the sidewall of the tyre (B).

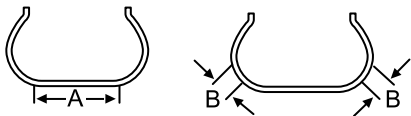

Changing a Wheel *

If you need to change the wheel during the journey, choose a safe place to stop away from the main road if possible. Always ask your passengers to get out of the car and wait in a safe area away from other traffic.

Switch on hazard warning lamps. If available, position a warning triangle about 50 to 150 metres behind your vehicle to warn approaching traffic.

Before changing a wheel, ensure the front wheels are in the straight ahead position. Apply the parking brake and place the shift control knob in the N position.

Observe the following precautions:

- Ensure the jack is positioned on firm, level ground.
- If the vehicle must be parked on the hill, place chocks in front of and behind other 3 wheels to prevent the vehicle moving.

Positioning the Jack



NEVER work beneath the car with the jack as the only means of support. The jack is designed for wheel changing only!

EMERGENCY INFORMATION



NEVER jack the car using any areas other than the designated jacking points. Serious damage to the car could result.

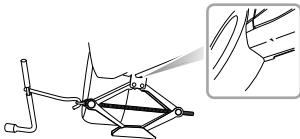
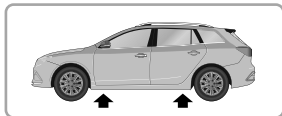

Avoid accidental contact with any underbody parts, especially high voltage components.

Position the jack on firm level ground under the jacking point nearest the wheel to be removed. Note that the

domed head of the jack must fit into the corresponding recess in the sill plate (There is a triangle indicator in the area shown by the arrowhead. See the illustration above).

Turning the jack screw by hand, adjust the jack until the jack head fits snugly onto the sill in the correct area. Ensure that the base of the jack is in full contact with the level ground.

Fitting the Spare Wheel



Regularly check the spare wheel tyre pressure, it may not be used for long periods of time. After fitment, at the first opportunity check and adjust the tyre pressure.



The wheel bolts must be tightened to the specified torque after changing a wheel (115 ~ 125 Nm).

- Before raising the car, use the special tool supplied with the vehicle to remove each wheel bolt cap. Use the wheel bolt spanner to slacken each bolt half a turn anti-clockwise.

EMERGENCY INFORMATION

- 2 Turn the handle in a clockwise direction until the tyre is clear of the ground.
- 3 Remove the wheel bolts and place them in the tool tray to prevent them from being lost. Make sure the vehicle is steady and there is no risk of slip or movement before removing wheel bolts.
- 4 Remove the road wheel.

Note: *Avoid placing wheels face down on the ground - the surface may be scratched.*

- 5 Fit the spare wheel and tighten the wheel bolts with wheel bolt spanner until the wheel is seated firmly against the hub.
- 6 Lower the car and remove the jack, then FULLY tighten the wheel bolts in a diagonal sequence.
- 7 Finally, return the tools to the toolbox, put the toolbox into the well of the boot floor, tighten the spare wheel retaining nuts, and put the replaced wheel above the toolbox in the well in the load space floor (face down). Lower the boot floor, and put the boot storage box on the boot floor.

Note: *DO NOT stand on the handle of the wheel bolt spanner or use extension tube on the handle of the spanner.*

Note: *When replacing the wheel, please fully tighten the bolts in the diagonal sequence twice.*

Note: *Consult your MG Authorised Repairer. or tyre specialist for a replacement tyre, as soon as possible.*

Spacesaver Spare Wheel



Only one spacesaver spare wheel can be used at any one time, otherwise the operational performance and brake performance may be reduced, thereby leading to accident or injury to yourself and others.



When driving on icy or slippery surfaces it is advised to fit the spacesaver wheel to the rear of the vehicle to maintain adequate stability. This may mean swapping a front wheel with a rear wheel.

EMERGENCY INFORMATION



Snow chains can not be used on the spacesaver spare wheel, this can cause damage to the car and snow chain.

When the spacesaver spare wheel is fitted, the vehicle speed should not exceed 50 mph (80 km/h). Please have the full-size tyre repaired and replace the spare wheel as soon as possible. This will extend the life span of the spare wheel for other emergencies.

Note: DO NOT use an automatic car wash when the spacesaver wheel is fitted, the guide rails of the car wash may conflict with the wheel/tyre and cause damage.

Fuse Replacement

Fuse

Fuses are simple circuit breakers which protect the car's electrical equipment by preventing the electrical circuits from being overloaded. A blown fuse may be indicated when the item of electrical equipment it protects stops working.

If you suspect a fuse it can be checked by removing it from the fuse box and looking for a break in the wire inside the fuse.

It is recommended to have spare fuses in the vehicle, which can be obtained from a local MG Authorised Repairer.

IMPORTANT

- NEVER attempt to repair a blown fuse. ALWAYS replace a fuse with one of the same rating, failure to use the correctly rated fuse could result in a fire or electrical circuit damage due to overloading.
- If a replaced fuse fails immediately, please contact an MG Authorised Repairer as soon as possible.

Fuse Box

The vehicle is equipped with 2 fuse boxes:

- Passenger compartment fuse box (behind the driver side lower trim panel)
- Front compartment fuse box (front left of the front compartment)

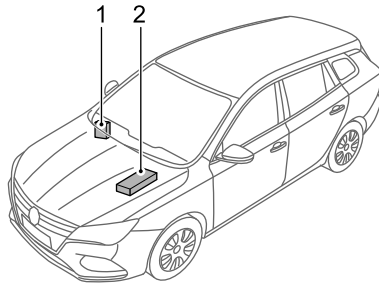

- 1 Passenger compartment fuse box
- 2 Front compartment fuse box

EMERGENCY INFORMATION

Passenger Compartment Fuse Box

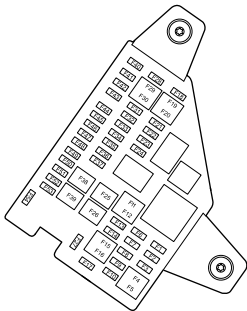

Check or Replace a Fuse

- 1 Turn off the Start/Stop Switch and all electrical appliances, and disconnect the negative battery cable.
- 2 Remove the driver side dashboard end cover plate and lower trim panel to access the fuse box.

- 3 Check a suspect fuse by removing it from the fuse box and looking for a break in the wire inside the fuse.
- 4 If a fuse is blown, replace it with another fuse of the same type and same ampere value.

Fuse Specification

Code	Specs	Function
F1	15A	Front Console Power Socket
F2	5A	Interior Mirror, Rear Console USB Charging Ports
F3-F17	-	-
F18	5A	TBOX, Vehicle Control Unit, Sensing Diagnostic Module (Airbag), Shifter Control Unit, Instrument Pack
F19	5A	AC Front Panel

EMERGENCY INFORMATION

Code	Specs	Function
F20	10A	AC Control Module
F21	10A	Front Right Seat Heater
F22	5A	Diagnostic Socket
F23	10A	Front Left Seat Heater
F24	5A	PEPS Control Module
F25	-	-
F26	30A	Front Left Window Lift, Rear Right Window Lift
F27	-	-
F28	5A	Backup Immobilizer Coil
F29	15A	Entertainment System
F30	5A	Instrument Pack
F31	5A	EPB Switch
F32	5A	Rain Light Sensor

Code	Specs	Function
F33	10A	Sensing Diagnostic Module (Airbag)
F34	10A	Driver Door Switch Pack, Gateway
F35–F36	-	-
F37	25A	Driver Electric Seat Adjustment
F38	-	-
F39	40A	Blower
F40-F43	-	-
F44	5A	Radio Broadcasting Reception Module
F45	10A	Electronic Steering Column Lock
F46	-	-

EMERGENCY INFORMATION

Code	Specs	Function
F47	5A	High Voltage Electric Heater
F48	-	-
F49	5A	TBOX
F50	10A	Gateway
F51	5A	Shifter Control Unit, Tyre Pressure Monitoring System
F52	5A	Door Mirrors and Headlamp Levelling Adjustment Switch
F53	5A	Pedestrian Alert Control Module
F54	-	-

EMERGENCY INFORMATION

Front Compartment Fuse Box

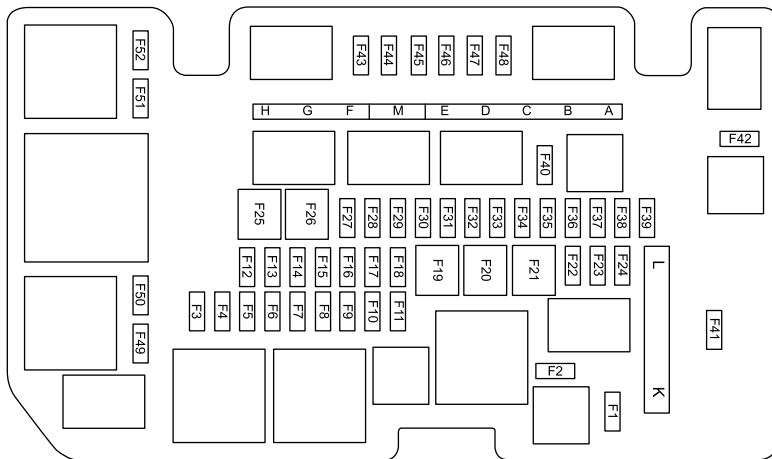

5

EMERGENCY INFORMATION

Check or Replace a Fuse

- 1 Turn off the Start/Stop Switch and all electrical appliances, and disconnect the negative battery cable.
- 2 Press the lock catch to open the upper cover of front compartment fuse box.
- 3 Check a suspect fuse by removing it from the fuse box and looking for a break in the wire inside the fuse.
- 4 If a fuse is blown, replace it with another fuse of the same type and same ampere value.

Fuse Specification

Code	Specs	Function
F1	120 Ω	On-board Network Terminal Resistance
F2	120 Ω	On-board Network Terminal Resistance
F3	30A	Body Control Module
F4	20A	Body Control Module

Code	Specs	Function
F5	15A	Body Control Module
F6	5A	Charging Plug Latch
F7	5A	Vehicle Control Unit
F8	30A	Electric Parking Motor Control Unit
F9	15A	Horn Relay, Horn
F10	-	-
F11	15A	High Voltage Battery Pack, Electric Vehicle Communication Controller, Battery Heater
F12–F24	-	-
F25	30A	Driver Door Switch Pack, Driver Window Lift, Rear Left Window Lift

EMERGENCY INFORMATION

Code	Specs	Function
F26	30A	Stability Control System (Valve)
F27	15A	Windscreen Washer System
F28	10A	Body Control Module
F29	20A	Body Control Module
F30	25A	Front Wiper System
F31	10A	Power Electronic Box
F32	25A	Body Control Module
F33	20A	Superlock System
F34	15A	Main relay, Power Electronic Box Water Pump, Brake Lamp Switch
F35	5A	Combined Charging Unit

Code	Specs	Function
F36	5A	Electric Air Conditioning Compressor
F37	10A	Main Beam Relay, Main beam
F38	15A	Rear Wiper System
F39	15A	High—Voltage Battery Pack Coolant Pump
F40-F42	-	-
F43	7.5A	Heated Exterior Rearview Mirror
F44	25A	Heated Rear Window
F45	-	-
F46	5A	Door Mirrors and Headlamp Levelling Adjustment Switch, Manual Headlamp Levelling
F47	-	-

EMERGENCY INFORMATION

Code	Specs	Function
F48	5A	Charging Flap Motor
F49-F52	-	-
FUSE A	80A	Electric Power Steering Module
FUSE B	-	-
FUSE C	40A	Stability Control System (Pump)
FUSE D	-	-
FUSE E	-	-
FUSE F	30A	Electrical Parking Brake Control Module
FUSE G	50A	Cooling Fan
FUSE H	50A	iBooster
FUSE M	150A	Combined Charging Unit

Code	Specs	Function
FUSE L	30A	Electronic Parking Brake Control Module
FUSE K	100A	Passenger Compartment Fuse Box

Bulb Replacement

Bulb Specification

Bulb	Specifications
Headlamp High/Low Beam	HB3 60W
Front Direction Indicators	WY21W 21W
Reverse Lamps	W16W 16W
Stop Lamps	W21W 21W

Bulb	Specifications
License Plate Lamps	W5W 5W
Rear Direction Indicators	WY16W 16W
Front Courtesy Lamps	W5W 5W

Note: Other light sources not included in the list are LED , which cannot be replaced individually.

EMERGENCY INFORMATION

Bulb Replacement

Before replacing any bulb, turn off the START/STOP Switch and lighting switch to avoid any possibility of a short circuit.

Note: *Only replace bulbs with the same type and specification.*

If the bulb glass is scratched or contaminated, it may mean the bulb can not concentrate the light. Take care NOT to touch the glass with your fingers; If necessary, clean the glass with methylated spirits to remove fingerprints.

Consult an MG Authorised Repairer on specific replacement operation.

High/Low Beam Bulb Renewal

- 1 Open the bonnet—see “Bonnet” in the “Maintenance” section.
- 2 Disconnect the battery negative terminal.
- 3 Remove 10 screws fixing the front compartment trim cover to the body, and remove the front compartment trim cover.
- 4 Identify and locate the high/low beam bulb cover plug. Rotate the cover anti-clockwise and remove the cover plug.

EMERGENCY INFORMATION

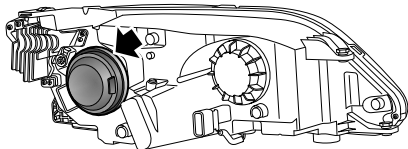

- 5 Rotate the bulb anti-clockwise and remove.
- 6 Remove the wiring connector from the bulb.
- 7 Refit the wiring connector to the new bulb.
- 8 Locate the bulb holder in the lamp, rotate clockwise until fully secured.
- 9 Refit the bulb cover plug, rotate clockwise until fully secure.

- 10 Connect the negative battery terminal.
- 11 Test lamp operation.
- 12 Refit the front compartment trim cover to the body.
- 13 Close the bonnet—see “Bonnet” in the “Maintenance” section.

EMERGENCY INFORMATION

Front Direction Indicators Bulb Renewal

- 1 Open the bonnet—see “Bonnet” in the “Maintenance” section.
- 2 Disconnect the battery negative terminal.
- 3 Remove 10 screws fixing the front compartment trim cover to the body, and remove the front compartment trim cover.
- 4 Identify and locate the bulb cover plug. Rotate the cover anti-clockwise and remove the cover plug.

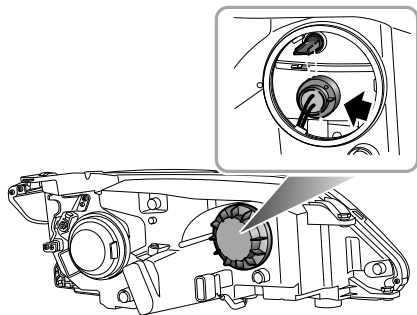

- 5 Remove the bulb holder from the lamp unit. Remove the bulb.
- 6 Fit new bulb. Locate the bulb holder in the lamp assembly, ensure it is fully secured.
- 7 Locate the bulb cover, rotate clockwise until fully secure.
- 8 Connect the negative battery terminal.

EMERGENCY INFORMATION

- 9 Test lamp operation.
- 10 Refit the front compartment trim cover to the body.
- 11 Close the bonnet—see “Bonnet” in the “Maintenance” section.

Reverse Lamps Bulb Renewal

- 1 Disconnect the battery negative terminal.
- 2 Open the tailgate.
- 3 Using a suitable pry bar or lever, carefully remove the cover trim.
- 4 Rotate the bulb holder anti-clockwise and remove the bulb from holder.

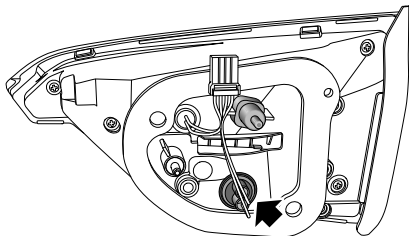

EMERGENCY INFORMATION

- 5 Fit the new bulb into the holder.
- 6 Insert bulb holder in lamp assembly, rotate clockwise until fully secure.
- 7 Connect the negative battery terminal.
- 8 Test lamp operation.
- 9 Refit the cover trim.
- 10 Close tailgate.

Stop Lamps Bulb Renewal

- 1 Disconnect the battery negative terminal.
- 2 Open the tailgate.
- 3 Using a suitable pry bar or lever, carefully release and remove the securing screw cover trim.
- 4 Remove the 2 screws securing the lamp to the body.

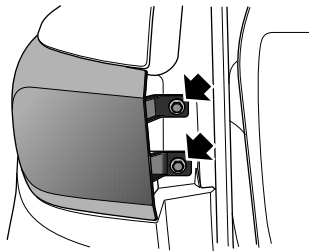

- 5 Release the lamp from the front fixing and withdraw from body, disconnect the wiring connector.
- 6 Rotate the bulb holder in an anti-clockwise direction.

EMERGENCY INFORMATION

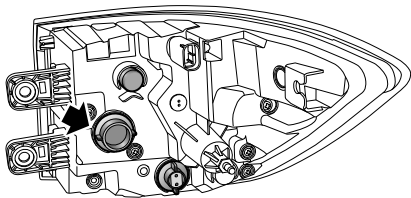

- 7 Remove bulb holder and remove bulb.
- 8 Fit new bulb to bulb holder.
- 9 Insert bulb holder in lamp assembly, rotate clockwise until fully secure.
- 10 Reconnect the wiring connector, position the lamp to the body, ensure the front retaining clip is aligned and fully located. Push the lamp forwards to locate in the clip. Fit screws and tighten to 2.7 - 3.3 Nm .

- 11 Refit screw cover trim.
- 12 Reconnect battery negative terminal.
- 13 Test lamp operation.
- 14 Close tailgate.

EMERGENCY INFORMATION

License Plate Lamps Bulb Renewal

- 1 Disconnect the battery negative terminal.
- 2 Open the tailgate.
- 3 Using a suitable tool, carefully remove the tailgate lower panel retaining screw covers, and remove 2 screws fixing the tail gate lower trim panel assembly to the tail gate.
- 4 Using a suitable pry bar, release the tailgate securing clips and remove the tailgate trim.
- 5 Carefully lever the lamp out of the aperture.
- 6 Release the bulb from the bulb holder.

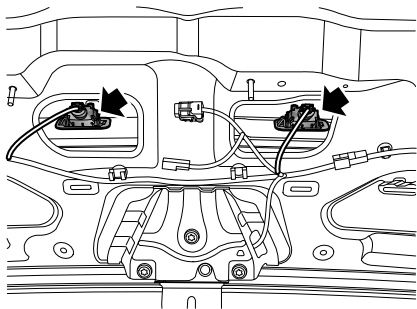

- 7 Insert the new bulb in the lamp bulb holder.
- 8 Position the lamp in the tailgate, and push until fully secured.
- 9 Position the tailgate trim to align the clips, gently tap the trim toward the tailgate to ensure the clips are fully located secure and refit 2 screws fixing the tailgate lower trim panel assembly to the tailgate.

EMERGENCY INFORMATION

- 10 Refit the lower tailgate trim panel retaining screw covers.
- 11 Reconnect battery negative terminal.
- 12 Test lamp operation.
- 13 Close tailgate.

Rear Direction Indicators Bulb Renewal

- 1 Disconnect the battery negative terminal.
- 2 Open the tailgate.
- 3 Using a suitable pry bar or lever, carefully release and remove the securing screw cover trim.
- 4 Using a suitable 10 mm spanner/socket wrench, remove the 2 screws securing the lamp to the body.

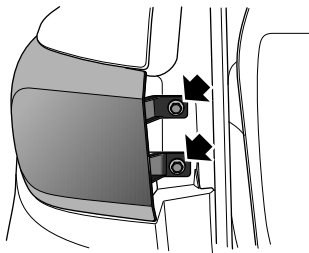

- 5 Release the lamp from the front fixing and withdraw from body, disconnect the wiring connector.
- 6 Rotate the bulb holder in an anti-clockwise direction.

EMERGENCY INFORMATION

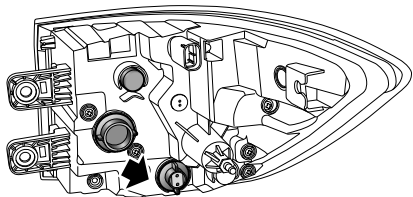

- 7 Remove bulb holder and remove bulb.
- 8 Fit new bulb to bulb holder.
- 9 Insert bulb holder in lamp assembly, rotate clockwise until fully secure.
- 10 Reconnect the wiring connector, position the lamp to the body, ensure the front retaining clip is aligned and fully located. Push the lamp forwards to locate in the clip. Fit screws and tighten to 2.7 - 3.3 Nm .
- 11 Refit screw cover trim.
- 12 Reconnect battery negative terminal.
- 13 Test lamp operation.
- 14 Close tailgate.

Front Interior Lamp Bulb Renewal

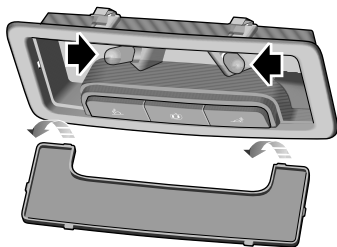

- 1 Disconnect the battery negative terminal.
- 2 Use a small flat-bladed screwdriver to gently prise the lens from the lamp assembly.
- 3 Pull the bulb from its mounting to remove.

Installation of the bulb is a reversal of the removal process. When installing the lens, locate the two prongs at the front of the lens and then carefully flex the lens to locate the two prongs at the rear of the lens into the lamp assembly. Push the lens upwards until it 'clicks' into position.

Maintenance

222 *Maintenance*

225 *Bonnet*

227 *Front Compartment*

228 *Cooling System*

231 *Brake*

233 *Battery*

235 *High Voltage Battery Pack*

237 *Washer*

239 *Wipers*

242 *Tyre*

248 *Cleaning and Vehicle Care*

MAINTENANCE

Maintenance

Routine Servicing

The safety, reliability and performance of your car will depend partly on how well it is maintained. You must ensure that maintenance is carried out when required and according to the information contained in the "Service Schedule" - see www.mg.co.uk - owners section.

Servicing

For next service information please consult your service records.

Some markets feature a service reminder in the IPK message centre.

Service History

Ensure MG Authorised Repairer registers the Service History after each service.

Brake Fluid Replacement

Replace the brake fluid according to the information contained in the "Service Schedule" - see www.mg.co.uk - owners section.

Note: Brake fluid replacement will be an additional cost.

Coolant Replacement

The coolant (anti-freeze and water solution) needs to be replaced according to the information contained in the "Service Schedule" - see www.mg.co.uk - owners section.

Note: Coolant replacement will be an additional cost.

Owner Maintenance



Any significant or sudden drop in fluid levels, or uneven tyre wear, should be reported without delay to MG Authorised Repairer.

In addition to the routine services referred to previously, a number of simple checks must be carried out more frequently. Advice is given on the pages that follow.

Daily Check

- Operation of lights, horn, wipers, washers and warning lamps.
- Operation of seat belts and brakes.
- Look for fluid deposits underneath the car that might indicate a leak.
- Check tyre appearance.

Weekly Check

- Coolant levels.
- Brake fluid level.
- Windscreen washer fluid level.
- Operate air conditioning.

Special Operating Conditions

If your car is frequently used in dusty conditions, or operated in extreme climates where sub-zero or very high ambient temperatures are normal, more frequent attention may need to be paid to servicing requirements. You need to carry out special maintenance operations (refer to Service Schedule) or contact an MG Authorised Repairer.

Safety in the Garage



Cooling fans may commence operating after the vehicle is switched off, and continue operating for a number of minutes. Keep clear of all fans while working in the front motor compartment

If you need to carry out maintenance, observe the following safety precautions at all times:

- If the car has been driven recently, **DO NOT TOUCH** cooling system components until the drive motor has been fully cooled down.

MAINTENANCE

- DO NOT TOUCH electrical leads or components when the START/STOP Switch is on.
- DO NOT work underneath the car with a wheel changing jack as the only means of support.
- Wear protective clothing and work gloves.
- Remove watches and jewelery before working in the front compartment.
- DO NOT allow tools or metal parts of the car to make contact with the battery leads or terminals.

Toxic Liquid

Fluids used in motor vehicles are poisonous and should not be consumed or brought into contact with open wounds. These include: battery acid, coolant, brake fluid and windscreen washer fluid.

For your own safety, ALWAYS read and obey all instructions printed on labels and containers.

Bonnet

Opening the Bonnet



DO NOT drive when the bonnet is not closed or retained only by the safety catch.

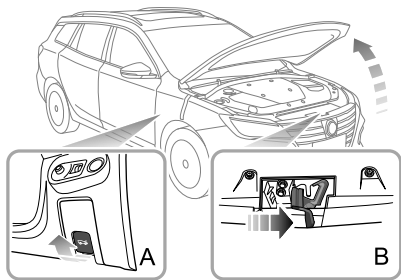

- 1 From the inside of the vehicle, pull the bonnet release handle (Figure A).

- 2 Move the safety catch release handle on the bonnet lock assembly in the direction of the arrow (Figure B) to release the bonnet safety catch.
- 3 Raise the bonnet, hold it up, insert the bonnet support rod into the aperture provided (indicated with an arrow). Ensure the bonnet support rod is securely located and release the bonnet.

Closing the Bonnet

Support the bonnet by one hand, release the support rod using the other hand, and place it firmly into the support rod base. Then hold the bonnet using both hands and lower it, allowing it to drop for the last 20cm ~ 30cm to fully close the bonnet.

By attempting to lift the front edge of the bonnet, check if the lock is fully engaged after closing the bonnet. If it is not fully engaged, you must repeat the operation.

Bonnet Open Warning

If the bonnet is not fully engaged, when the START/STOP switch is in the ON/READY position, the corresponding alarm icon will be displayed in the information message

MAINTENANCE

centre of the instrument pack. If it is detected that the bonnet is not fully engaged whilst driving, an audible warning will sound.

IMPORTANT

- For safety reasons, the bonnet should be fully latched when driving. Therefore every time the bonnet is opened, you must check after closing that the bonnet is securely latched, e.g. the bonnet edge is flush with the body of the car.
- You should stop the car immediately when safety permits and close the bonnet if it is not closed fully when driving.
- Beware of injury to hands while fully closing the bonnet with a downward force.

Front Compartment



While working in the front compartment, always observe the safety precautions listed under 'Safety in the Garage', refer to 'Maintenance' in 'Maintenance' section.

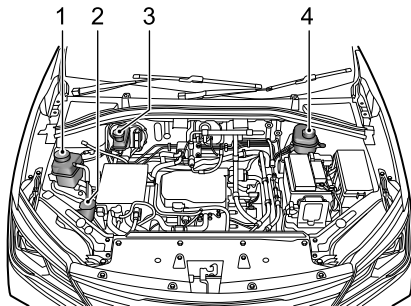

- 1 Electric drive transmission coolant expansion tank (black cap)
- 2 Washer fluid reservoir (blue cap)
- 3 Brake fluid reservoir (black cap)
- 4 Battery coolant expansion tank (black cap)

MAINTENANCE

Cooling System



DO NOT remove the coolant pressure cap when the cooling system is hot - escaping steam or hot coolant could cause serious injury.

Note: Prevent coolant coming into contact with the vehicle body when topping up. Coolant will damage paint.

If the coolant level falls appreciably during a short period, and you suspect that there may be a leak, please seek an MG Authorised Repairer for service.

Coolant Check and Top Up-EDS

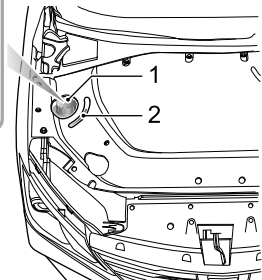
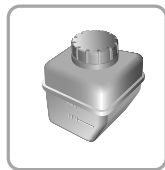

- 1 Coolant Expansion Tank Cap
- 2 Viewport

The cooling system should be checked weekly when the cooling system is cold and with the car resting on level ground. Open the bonnet to check the coolant level from the viewport. If the coolant level is below "MIN" mark,

open the coolant expansion tank cap and top up coolant. The coolant level should not be higher than "MAX" mark.

Coolant Check and Top Up-ESS

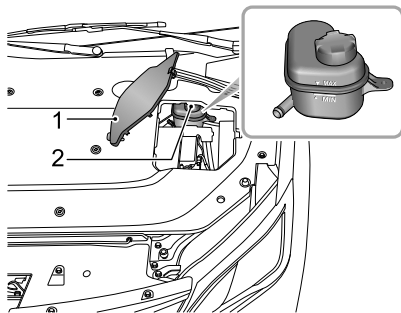

- 1 Battery Cover
- 2 Coolant Expansion Tank Cap

The cooling system should be checked weekly when the cooling system is cold and with the car resting on level

ground. Open the bonnet, lift the battery cover and check the coolant level. If the coolant level is below "MIN" mark, open the coolant expansion tank cap and top up coolant. The coolant level should not be higher than "MAX" mark.

Coolant Specification

! *Coolant is poisonous and can be fatal if swallowed - keep coolant containers sealed and out of the reach of children. If accidental contact of coolant by children is suspected, seek medical assistance immediately.*

! *Prevent the coolant coming into contact with the skin or eyes. If this occurs, rinse immediately with plenty of water. If eyes are still red, painful or uncomfortable, seek medical attention immediately.*

Please use the coolant (mix of water and antifreeze) which is recommended and certified by MG UK. Please refer to 'Recommended Fluids and Capacities' in "Technical Data" chapter.

MAINTENANCE

Note: In an emergency, top up the coolant expansion tank with a small amount of clean water, but be aware of the resultant reduction in frost protection.

Note: The addition of corrosion inhibitors or other additives to the cooling system of this car may severely disrupt the efficiency of the system and cause electric drive system(EDS) and high voltage battery pack(ESS) damage. For cooling system issues please consult an MG Authorised Repairer.

Brake

Brake Pads



DO NOT rest your foot on the brake pedal while driving; this may overheat the brakes, reduce their efficiency and cause excessive wear.

For the first 900 miles(1500 km) you should avoid situations where heavy braking is required.

Remember that regular servicing is vital to ensure that all the brake components are examined for wear at the correct intervals, and replaced when required to ensure long term safety and optimum performance during the intervals outlined in the Service Schedule.

The vehicle needs to run in for 500 miles(800 km) after brake pad or disc replacement.

Brake Fluid Check and Top Up



Brake fluid is highly toxic, keep containers sealed and out of the reach of children. If accidental contact of brake fluid is suspected, seek medical attention immediately.



Prevent brake fluid coming into contact with the skin or eyes. If this occurs, rinse immediately with plenty of water. If eyes are still red, painful or uncomfortable, seek medical attention immediately.

The brake fluid level should be checked weekly when the system is cold and with the car on level ground.

The brake fluid level can be seen through the reservoir and should be maintained between the "MAX" and "MIN" marks.

Note: Do not allow the brake fluid level to drop below the "MIN" mark or rise above the "MAX" mark.

MAINTENANCE

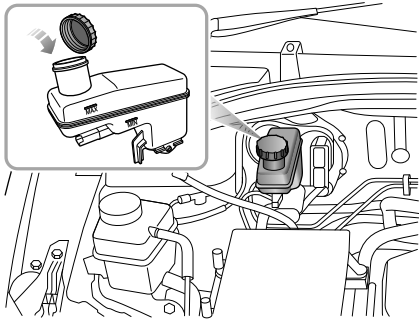

Note: Brake fluid will damage painted surfaces. If you accidentally spill the brake fluid on the painted surface, soak up any spillage with an absorbent cloth immediately and wash the area with water or car shampoo.

Brake Fluid Specification

Use the brake fluid recommended and approved by the manufacturer. Refer to "Recommended Fluids and Capacities" in the "Technical Data" section.

IMPORTANT

Replace brake fluid regularly according to the Service Schedule.

Battery

Battery Maintenance



DO NOT leave electric components switched on when the vehicle is not in **READY** mode, otherwise the battery may become flat, resulting in the failure to start the vehicle and the reduction of battery life.



Always store batteries upright, tilting may allow the corrosive substances contained within the battery to leak out.



Never attempt to dismantle a battery, they are sealed units.

The battery will be visible after the bonnet or the front compartment trim panel is opened. The battery is maintenance-free, therefore there is no need to refill fluid.

Note: It is recommended to set the power mode to **READY** for half an hour every week to help extend the service life of the battery. If the vehicle is stored for more than 1 month, remove the negative terminal from

the battery. Make sure that the vehicle power system has been turned off before connecting or disconnecting the negative terminal.

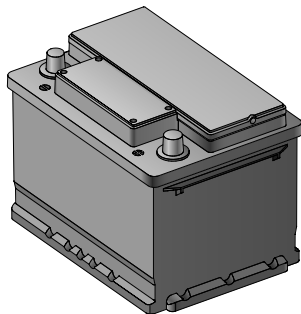

Battery Replacement



The battery contains sulphuric acid, which is corrosive.

MAINTENANCE

The battery contains sulphuric acid, which is corrosive. Please go to an MG Authorised Repairer to remove and refit the battery. Only fit a replacement battery of the same type and specification as the original to maintain the correct vehicle functionality.



The used battery should not be discarded at will, for it is harmful to the environment. It must be recycled by professional institutes. Please consult an MG Authorised Repairer for more details.

High Voltage Battery Pack

Precautions and restricted conditions for use of battery



If the vehicle is not going to be used, parked, or stored for a long time it is necessary to charge the vehicle at least once every 3 months. During this time, the High Voltage battery state of charge should not be allowed to drop below 50%.



*If the battery is in a low state of charge and the instrument pack displays '—' this indicates that the range is below 10 miles (15km), in this case the vehicle **MUST NOT** be left in a stored state for more than 7 days without being charged to above 50%.*



Failure to follow these guidelines will result in HV battery damage and invalidate the warranty.



DO NOT attempt to dismantle the battery pack or any High Voltage components - THESE ARE DANGEROUS. Any signs of dismantling or damage caused by attempts to dismantle will invalidate the warranty.

- 1 DO NOT park the vehicle in conditions where the ambient temperature exceeds 45°C for more than 15 days. This will effect the performance and service life of the high voltage battery.
- 2 To maintain or improve the service life of the high voltage battery, it is recommended that you use a slow charging method wherever possible, rapid charging should only be used for long distance journeys or emergencies.
- 3 It is recommended using the vehicle at least once a month.

Where possible it is recommended that you carry out a slow charging (equalisation charging) every month to extend the service life of high-voltage battery pack. The battery management system will monitor the status of the high- voltage battery pack; after

MAINTENANCE

monitoring for a period of time, if an equalising charge has not been carried out for some time the message centre in the instrument pack will display 'Please Charge for BMS Balance'. At this time you must carry out an equalising charge. For operation mode, please refer to 'Equalisation Charging' in 'Starting & Driving' section.

- 4 In the event of an accident, damage to the high voltage battery or any of its related components, or any repairs made to the high voltage system the car must be inspected by qualified personnel at an MG Authorised Repairer.
- 5 In the event of any accident or body repairs being required please consult the qualified personnel at an MG Authorised Repairer. The repair may require high voltage battery isolation or specialist HV component removal.

IMPORTANT

Only fully trained and qualified personnel are allowed to work on the high voltage systems and components of this vehicle. Any disassembly of such systems or components is strictly prohibited.

Washer

Windscreen Washer Fluid Check and Top Up



When filling the washer fluid, DO NOT let the washer fluid spill on the paint surface of vehicle body. In case the washer fluid is spilled on hands or other parts of the body, please immediately wash with clean water.

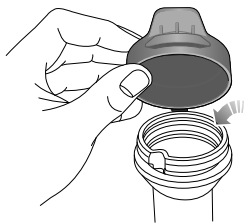

Check the washer fluid level every week. When the level of washer fluid is low, please top up the washer fluid as instructed.

Note: DO NOT use an anti-freeze or vinegar/water solution in the washer reservoir - anti-freeze will damage paintwork while vinegar will damage the washer pump.

IMPORTANT

- Use the washer fluid recommended and certified by the manufacturer. Misuse of washer fluid in winter may cause damage to the washer motor due to freezing.
- Using the washer switch when there is no washer fluid may cause damage to the washer motor.
- Operating the wipers when the windscreen is dry and there is no washer fluid may cause damage to the windscreen and wipers. Please spray the washer fluid and start the wipers when there is adequate washer fluid.

MAINTENANCE

Washer Nozzles

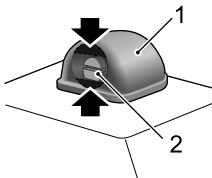

Operate the washers periodically to check that the nozzles are clear and properly directed.

The windscreen washer nozzles are configured during the production, so generally there is no need for adjustments. To adjust the windscreen washer nozzle, you can insert a small flat-bladed screwdriver in the upper and bottom gaps (as indicated by the arrow) between the housing (1) and the nozzle (2) and turn downward or upward slightly to adjust to appropriate injection angle.

If the nozzle is obstructed, insert a needle or thin metal wire into the hole to remove the obstruction.

Washer Fluid Specification

Use the washer fluid recommended and certified by the manufacturer. Refer to "Recommended Fluids and Capacities" in the "Technical Data" section.

Wipers

Wiper Blades

IMPORTANT

- Grease, silicon and petroleum products impair the blade's wiping capability. Clean the wiper blades in warm soap water, and check their status periodically.
- Clean the windscreen frequently. **DO NOT** use wipers to remove stubborn or ingrained dirt, it will reduce their effect and their life span.
- If signs of hardness or cracking in the rubber are found, or if the wipers leave streaks or unwiped areas on the screen, then the wiper blades should be replaced.
- Clean the windscreen regularly with an approved glass cleaner and ensure the windscreen is thoroughly cleaned before fitting replacement wiper blades.
- Only fit replacement wiper blades that are identical to the original specification.
- Clean ice and snow from the wipers and ensure they are not frozen or otherwise sticking to the windscreen before attempting to operate them.

MAINTENANCE

Replacing Front Windscreen Wiper Blades

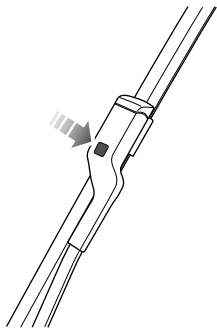

- 1 With the bonnet in closed state, and within 20 seconds of setting the START/STOP Switch to the OFF position, operate the wiper stalk switch by pressing down and releasing, the wipers will enter the 'service position' and stop on the windscreen.
- 2 Lift the wiper arm away from the windscreen.
- 3 Press the button on the wiper arm (as illustrated), and pull the upper end of the wiper blade outward to disengage from the wiper arm.
- 4 Unhook the blade from the wiper arm and discard.
- 5 Locate the new wiper into the slot of the wiper arm.
- 6 Push the wiper blade towards the arm until the wiper blade is engaged.
- 7 Check whether the wiper blade is fitted correctly to the arm before positioning on the windscreen.
- 8 Operate the wiper stalk switch by pressing down again and releasing, or set the START/STOP Switch to ON, the wipers will exit the service mode and automatically return to its original position

Replacing Rear Wiper Blades

4 Place the wiper assembly back on the rear window.

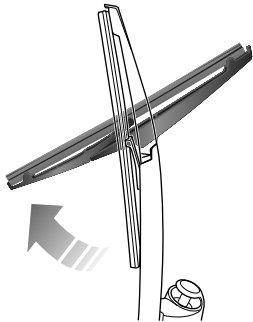

- 1 Lift the wiper arm away from the rear window.
- 2 Rotate the wiper blade as shown in the figure, to remove it from the wiper arm and discard.
- 3 Position the fitting of the new wiper blade into the slot of the wiper arm. Ensure the wipers blade is properly secured on the wiper arm.

MAINTENANCE

Tyre

Overview

- Take extra care when using new tyres for the first 300 miles (500km).
- Avoid excessive cornering at speed.
- Regularly check tyres for signs of damage. **DO NOT** remove foreign objects such as screws or nails from the tyre. If a tyre shows any signs of damage please ensure it is inspected by a reputable tyre fitter for advice.
- Prevent tyres coming into contact with any chemicals such as oil, grease or fuel.
- Ensure valve caps are always fitted.
- If the tyre is to be removed always mark the tyre/wheel orientation to ensure correct reinstallation.
- If removed tyres are to be stored, please ensure they are kept in dark, dry and cool conditions.

New Tyres

New tyres may not have the same adhesion properties of the old tyres, please run in at moderate speed in

appropriately careful driving style for the first 300 miles (500km). This action could benefit tyre life.

The damage of a tyre or rim may happen unnoticed. If abnormal vibration or handling is experienced, that means the tyre or rim may have been damaged. Please slow down and park your vehicle in a suitable, safe location, then check the tyre and rim. If you can't see the damage from the outside continue to drive the vehicle slowly to a reputable tyre fitter or MG Authorised Repairer for inspection and advice.

Directional Tyres

Directional tyres are marked with 'direction of rotation' (DOR). To maintain handling characteristics, tyre performance, low road noise and extend tyre life, tyres must always be fitted with indication arrow showing the correct 'DOR'.

Tyre Life

Correct tyre pressures and moderate driving style can extend tyre life. Recommendations:

- If the vehicle is to be stored for a lengthy time, please move your vehicle at least once every two weeks to 'rotate the tyres'.
- Tyre pressures should be checked monthly when the tyres are cold.
- Avoid cornering at excessive speeds.
- Regularly check tyres for abnormal wear patterns.

The following factors affect the tyre life:

Tyre Pressures

Incorrect tyre pressures can result in poor driving characteristics and a shortened tyre life due to abnormal wear.

Driving Style

Excessively harsh acceleration and braking (tyres emit a harsh noise) whilst cornering will reduce tyre life.

Wheel Balance

Every new vehicle leaves the factory having had the wheels dynamically balanced. Out of balance wheels may be due to many factors.

If wheels are out of balance, shaking or vibration of the steering mechanism may occur and the tyres may start to wear excessively. It is important to restore wheel balance as quick as possible. Each wheel should be rebalanced after installing a new tyre or having a tyre repair.

Wheel Alignment

Incorrect wheel alignment can cause excessive tyre wear and affect vehicle safety. If the tyres show signs of abnormal wear, check the wheel alignment and seek advice from an MG Authorised repairer.

MAINTENANCE

Caring for Your Tyres



DEFECTIVE TYRES ARE DANGEROUS!
DO NOT drive if any tyre is damaged, is excessively worn, or is inflated to an incorrect pressure.

Always drive with consideration for the condition of the tyres, and regularly inspect the tread and side walls for any sign of distortion (bulges), cuts or wear.

Note: Avoid tyre contact with oils, grease and fuel.

Tyre Pressures



Before a long distance journey, the tyre pressures should be checked.

Check the pressures at least every month, when the tyres are cold.

If it is necessary to check the tyres when they are warm, you should expect the pressures to have increased by 0.3 ~ 0.4bar (4.35 ~ 5.8psi). In this circumstance, NEVER let air out of the tyres in order to match the recommended pressures (cold).

Valves

Keep the valve caps firmly secured - they prevent dirt from entering the valve. Check the valve for leaks (listen for a tell-tale hissing) when you check the tyre pressure.

Punctured Tyres

Your vehicle is fitted with tyres which may not leak if penetrated by a sharp object, provided the object remains in the tyre. If you are aware of this occurring, reduce speed immediately and drive with caution until the spare wheel can be fitted, or repairs undertaken.

Note: If the sidewall of the tyre is damaged or distorted, replace the tyre immediately, do not attempt a repair.

Tyre Wear Indicators

The original tyre treads have a 1.6 millimeter high wear mark indicator that is perpendicular to the wheel rolling direction. These indicators are moulded into the tread pattern at several points around the circumference. A mark on the side of a tyre, such as upper case lettering TWI or a triangle indicate the position of the wear mark.

When the tread has worn down to 1.6mm or below, the indicators will come to the surface of the tread pattern, producing the effect of a continuous band of rubber across the width of the tyre.

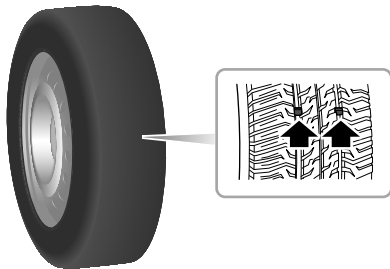

IMPORTANT

A tyre **MUST** be replaced as soon as a wear indicator becomes visible.

Replacement of Tyres



When replacing tyres it is strongly recommended that the new tyres are of the same specification as the original tyres. Alternative tyres, of a different specification, or unqualified tyres may adversely affect the car's driving characteristics and safety. In order to maintain comfort and safety it is recommended to seek advice from an MG Authorised Repairer.

Always have replacement wheels and tyres balanced before use.

Wheel Fitment Rotation

It is not recommended that you swap wheels from side to side or front to rear in order to equalise tyre wear. Your vehicle is fitted with Tyre Pressure Monitoring System which means that each wheel is programmed to the relative position.

MAINTENANCE

If you do wish to swap wheels and tyres around on the vehicle please consult an MG Authorised Repairer as extra coding will be required.

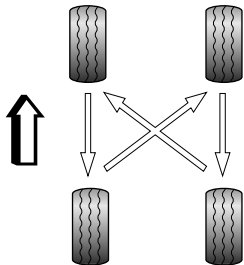

Tyre/Snow Chains

Unsuitable tyre/snow chains may damage the tyres, wheels, suspension, brakes or bodywork of your car.

Please pay attention to the following requirements in the usage:

- The tyre/snow chains can only be fitted on the front wheels;
- The thickness of tyre/snow chains must not exceed 12mm;
- Please always observe the installation and tension instructions for the tyre/snow chains, as well as the speed limitations of different roads;
- Do not drive faster than 30mph (50km/h);
- To avoid the tyre damage and excessive wear of the tyre/snow chains, the tyre/snow chains must be removed while driving on the road without snow.

For this vehicle, the only specification of wheels and tyres that will support tyre/snow chains are as follows:

Wheel rim size: 6.5J×16

Tyre size: 205/60 R16

Note: *If you drive on snow covered and icy roads, it is recommended to use winter tyres. Consult an MG Authorised Repairer for details.*

MAINTENANCE

Cleaning and Vehicle Care



Observe all safety precautions on cleaning products; do not drink fluids and keep them away from the eyes.

Exterior

Washing Your Car



Some high pressure cleaning systems will penetrate door, window and sunroof seals, and damage lock mechanisms. DO NOT aim water jets directly at components that might be easily damaged. Ensure the vehicle power system is OFF when washing your car.



Do not clean the front compartment with high pressure water since it may damage the electrical system of the vehicle.

In order to preserve the paint finish on your car, please observe the following care points:

- DO NOT use hot water to wash the car.
- DO NOT use detergents or washing up liquid.

- In hot weather, DO NOT wash the car in direct sunlight.
- When using a hose, DO NOT aim the water directly at window, door or sunroof seals, or through wheel apertures onto the brake components.

If the car is particularly dirty, use a hose to flush grime and grit from the bodywork, prior to washing. Then, wash the car using cold or lukewarm water containing a good quality wash and wax shampoo. Always use plenty of water to ensure that grit is flushed from the surface and not ground into the paintwork. After washing, rinse the bodywork with clean water and dry off with a chamois leather.

Cleaning the underside

Note: *DO NOT use a high pressure hose to clean the front compartment – damage to the car's electronic systems may occur.*

From time to time, but particularly during winter months when salt has been used on the roads, use a hose to wash the underside of the car. Flush away accumulations of mud and thoroughly clean those areas where debris can easily collect (wheel arches and panel seams, for example).

IMPORTANT

- Avoid cleaning the vehicle in direct sunlight.
- When cleaning the vehicle in winter avoid spraying water directly onto door locks and panel gaps due to risk of icing.
- Do not use rough sponges or cloth to clean the car, this will damage the paintwork finish.
- When cleaning the headlamps do not use a dry cloth or sponge, use only warm soapy water.

Cleaning with a High Pressure Cleaner

Note: Always read the manufacturers operating instructions.

When using high pressure washers, always ensure there is adequate distance between the spray nozzle and any soft materials, decals or rubber seals.

Note: **DO NOT** direct the pressure washer nozzle directly toward the high voltage charging point or high voltage battery connections on the underside of the vehicle.

IMPORTANT

- Please pay attention to the operating instructions of high pressure cleaner.
- High pressure cleaners should not be closely directed at soft parts of the vehicle.

Removing tar spots

Use white spirit to remove tar spots and stubborn grease stains from the paintwork. Then wash the area immediately with soapy water to remove all traces of the spirit.

Body Protection

After washing, examine the paintwork for damage. If the damage has revealed bare metal, use a colored primer first, then apply the correct colour base coat and finish off with a lacquer pencil, if appropriate. Carry out this treatment after washing but before polishing or waxing. More extensive damage to paint or bodywork must be repaired in accordance with the manufacturer's recommendations. Failure to do this will invalidate the Anti-Corrosion Warranty. If in doubt, ask your MG Authorised Repairer.

MAINTENANCE

Polishing the Paintwork



DO NOT use car polish containing coarse abrasives – these will remove the paint film and damage the gloss finish.

Occasionally treat the paint surface with an approved polish containing the following properties:

- Very mild abrasives to remove surface contamination without removing or damaging the paint.
- Filling compounds that will fill scratches and reduce their visibility.
- Wax to provide a protective coating between the paint and the elements.

Note: If possible, avoid applying polish or wax products to window glass and rubber seals.

Wiper Blades

Wash in warm soapy water. DO NOT use spirit or solvent based cleaners.

Windows and Mirrors

Regularly clean all windows, inside and out, using an approved glass cleaner.

Windscreen: In particular, clean the outside of the screen with glass cleaner after washing the car with wash and wax products, and before fitting new wiper blades.

Rear screen: Clean the inside with a soft cloth, using a side to side motion to avoid damaging the heating elements.

Note: DO NOT scrape or use abrasive cleaners on the inside of the rear screen – this will damage the heating elements.

Mirrors: Wash with soapy water. Use a plastic scraper to remove ice. DO NOT use abrasive cleaning compounds or metal scraper.

Plastic Components

Any plastic components should be cleaned using conventional cleaning methods and not be treated with abrasive materials.

Paint Damage

Any paint damage or stonechips should be treated with suitable paint/lacquer materials immediately to avoid invalidating the Anti Corrosion Warranty.

Weather Strips and Rubber Seals

Any weather strips or rubber aperture seals should be treated with suitable materials (silica gel) if they are cleaned using strong detergents, this should avoid any sticking and maintain the service life of the seal.

Wheels



When cleaning the wheels any materials or water that contact the brake disc directly may effect braking efficiency.

In order to ensure the wheels are kept in optimum condition they should be cleaned regularly.

Only use a recommended non-acidic propriety wheel cleaner. Always read the instructions on the product.

Cleaning the Interior

Plastic materials

Clean plastic-faced materials with diluted upholstery cleaner, then wipe with a damp cloth.

Note: DO NOT polish dashboard components – these should remain non-reflective.

Carpet and fabrics

Clean with diluted upholstery cleaner - test a concealed area first.

Leather

Clean leather trim with warm water and a non-detergent soap. Dry and polish the leather with a dry, clean, lint-free cloth.

Note: DO NOT use petrol, detergents, furniture creams or polishes as cleaning agents.

MAINTENANCE

Instrument Pack, Audio and Navigation Display

Clean with a dry cloth only. DO NOT use cleaning fluids or sprays.

Airbag Module Covers



DO NOT allow these areas to be flooded with liquid and DO NOT use petrol, detergent, furniture cream or polishes.

To protect damage to the airbag SRS, the following areas should be cleaned sparingly with a damp cloth and upholstery cleaner ONLY:

- Steering wheel centre pad.
- Area of dashboard containing the passenger airbag.
- Area of roof lining and front pillar finishers which enclose the side head impact protection modules.

Seat Belts



DO NOT use bleaches, dyes or cleaning solvents on seat belts.

Extend the belts, then use warm water and a non-detergent soap to clean. Allow the belts to dry naturally; DO NOT retract them or use the car until they are completely dry.

Technical Data

254 Technical Data Dimensions

256 Weights

*257 Major Parameters of High Voltage
Battery Pack*

258 Parameters of Traction Motor

*259 Recommended Fluids and
Capacities*

260 Wheel Alignment (Unladen)

260 Wheels and Tyres

260 Tyre Pressure (Cold)

TECHNICAL DATA

Technical Data Dimensions

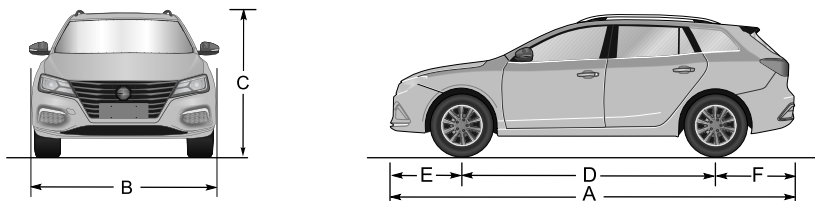

Item, Units	Parameter
Overall length A, mm	4544
Overall width B, mm	1818
Overall height C (unladen), mm	1513(body height) 1536(with roof bars)
Wheelbase D , mm	2665
Front overhang E, mm	934

TECHNICAL DATA

Item, Units	Parameter
Rear overhang F, mm	945
Front wheel track, mm	1558
Rear wheel track, mm	1553
Minimum ground clearance (laden), mm	116.1
Minimum turning circle diameter, m	11.3

Note: *Vehicle length not including the license plate.*

Note: *Rearview mirrors and the deformed portion of tyre wall directly above the touchdown point are not included in the total width.*

TECHNICAL DATA

Weights

Item, Units	Parameters	
	Exclusive	Excite
Person in cab, person	5	
Unladen vehicle weight (kerb), kg	1550	1532
Gross vehicle weight, kg	1992	1974
Unladen front axle weight, kg	887	877
Unladen rear axle weight, kg	663	655
Gross front axle weight, kg	991	981
Gross rear axle weight, kg	1001	993

Major Parameters of High Voltage Battery Pack

Item	Parameter Values
Type	Ternary lithium ion battery
Rated energy, kWh	52.5
Rated voltage, V	350
Weight, kg	361
Waterproof Grade	IP67

TECHNICAL DATA

Parameters of Traction Motor

Item	Parameter Values
Traction motor type	Three-phase permanent magnet synchronous motor
Continuous Power/Peak Power, kW	73/120
Rated Torque/Peak Torque, Nm	87.1/260
Rated Speed/Maximum Speed, Rotation/Score	8000/15000
Winding Type	△ winding
Waterproof Grade	IP67

Recommended Fluids and Capacities

Name	Grade	Capacity
High-voltage battery pack coolant, L	Glycol (OAT)	4.4
Electric drive transmission coolant, L	Glycol (OAT)	4.2
Electric drive transmission oil, L	Shell SL2808	0.9
Brake fluid, L	DOT 4	0.8
Screenwasher detergent, L	ZY-VIII	2.5
Air conditioning refrigerant, g	R1234yf	600±20

TECHNICAL DATA

Wheel Alignment (Unladen)

Item		Parameter
Front	Camber	-0°7'±45'
	Castor	5°12'±45'
	Toe in (Total)	0°12'±15'
	Kingpin Inclination	13°06'±45'
Rear	Camber	-1°13'±45'
	Toe in (Total)	0°6'±20'

Tyre Pressure (Cold)

Wheel	Unladen
Front Wheels	220kPa/2.2bar/32psi
Rear Wheels	220kPa/2.2bar/32psi

Wheels and Tyres

Wheel size	6.5J×16
Tyre size	205/60 R16 96V

- A**
- ABS (Anti-Lock Braking System) 22, 29, 164, 165
 - ABS Warning 22, 29
 - Accessory Power Socket 56
 - Accident Precautions 12
 - Adaptive Cruise Control 178-187
 - Air Conditioning 15, 64-77, 134-135, 207, 223, 259
 - Air Distribution 68-76
 - Air Recirculation 67, 68, 70-73, 76, 77
 - Air Vents 64-66, 70, 75
 - Airbag SRS 80, 86, 93, 97-107, 113, 202, 203, 252
 - Airbag SRS Service Information 102-104
 - Airbag SRS Warning 24, 27, 98
 - Airbags Driver and Front Passenger 100
 - Airbags – Side Head Curtain 102
 - Airbags – Side Pelvis/Thorax 101, 102
 - Alarm System 122-125
 - Alternative Starting Position 130-131
 - Anti Theft 121-125, 130
 - Auto Hold 22, 167-169
 - Auto Lamps 35
- B**
- Backrest Adjustment – Seats 80, 82-85, 181
 - Battery – Key 31, 117, 118
 - Battery (12V) Maintenance 233-234
 - Battery (12V) Replacement 233-234
 - Blower 67-77, 135, 203
 - Bonnet 15, 41, 122, 124, 125, 142, 183, 210-213, 225-226, 228, 229, 233, 240
 - Booster Cables 187-189
 - Britax Child Seats 112
 - Brake Fluid 22, 30, 222, 223, 227, 231-232, 259
 - Brake Fluid Specification 259
 - Brakes 135, 223, 231, 246
 - Braking in an Emergency 58, 60, 80, 134, 163, 169, 171, 181
 - Bulb Replacement 209-219
 - Bulb Specification 209
- C**
- Capacities 259
 - Car Wash Precautions 48, 167, 200, 248

INDEX

Centre Vents 64-65, 70, 75
Charging 9, 11, 25, 29, 32, 56-57, 137-150, 206-208
235-236
Charging Ports 9, 57, 140-145, 202
Charging Times 143, 148-150
Child Proof Locks 120
Child Restraints and Seats 51, 92, 97, 105-113
Cleaning – Car Interior 251-252
Cleaning – Paint Work 248-250
Clock 17
Coolant Check and Refill 228-229
Coolant Level 223, 228-229
Coolant Specification 229, 259
Cooperative Regenerative Braking System 162-163
Cruise Control 15, 21, 28, 135, 175-177
Cup Holder 61
Current Journey (Trip Computer) 19

D

Daily Checks 223
Data –Technical 254-260
Daytime Running Lamps 36

Dimensions 254
Dipped Headlamps 35-38
Direction Indicators 27, 38, 39, 184, 209, 212, 227
Direction Indicator Bulb 209, 212, 227
Driving on Hills 155
Driving Mode 15, 17-18, 135, 155-156, 162
Driving Range 8, 68, 74, 147, 162
Door Mirror 47-48, 128, 204, 207
Door Mirror Heater 47, 207

E

EBA (Electronic Brake Assistance) 163
EBD (Electronic Brake Force Distribution) 22, 30, 163
E Call 26, 34, 185-186
Economical Driving 133-134
Electric Drive Number 4-5
Electric Drive Transmission 4-5, 11, 151-152, 159-160,
227, 259,
Electric Motor 4, 5, 19-20, 25, 32, 159-160, 258
Electric Motor Number 4-5
Electric Vehicle 7, 138, 140, 206
Electronic Hydraulic Brake Application System 161

Electronic Parking Brake 22, 31, 32, 152, 155, 165, 167-169, 208
Electronic Steering Column Lock (ESCL) 23, 30
Emergency 3, 12, 26, 34, 80, 86, 87, 91, 94, 106, 131, 133-134, 142, 163, 164, 169-171, 183-219, 230
Emergency Braking Hazard Control System (HAZ) 169
Emergency Starting 187-189
Energy Flow 20
Energy Regeneration (KERS) 9, 15, 17, 18, 20, 135, 157-158
Environmental Driving 133-134
EPS (Electric Power Steering) 23, 30, 45-46
Equalisation 9, 143, 148-149, 235-236
ETC (Electronic –Temperature Control) * 67-71

F

Fog Lamps and Switch 27, 36, 39
Follow Me Home Lights 36
Foot Brake 161
Front Wiper Operation 40-41, 207

Front Wiper Blade Replacement 240
Fuses, Replacement 201-208
Fuse Box (Passenger Compartment) 202-204
Fuse Box (Front Compartment) 205-208

G

Gauges and Indicators 16
Gear Shift 15, 17, 43, 151-154, 176, 202
Glovebox 58

H

HAZ (Emergency Braking Hazard Warning Light Control) 169
Hazard Warning Lamp 3, 27, 39, 169, 184, 192
Hazard Warning Triangle 184
Head Restraints 80, 83-84,
Headlamp Bulb 209-210
Headlamp Flash 38
Headlamp Levelling 37, 207
Headlamps 35-39, 49, 204, 207, 209, 249
Heated Mirrors 47, 207
Heated Rear Window 47, 67, 71, 72, 76, 207

INDEX

Heavy Loads 133

High Voltage 7-11, 16-17, 20, 33, 135, 138, 140, 143, 148-151, 157, 192, 198, 204-206, 230, 235-236, 257, 259

High Voltage Battery Pack 7-9, 16, 20, 33, 135, 147, 206-207, 230, 235-236, 257

Hill Hold Function 155, 165-166

Horn 15, 46, 124, 129, 206, 223

Hydraulic Booster Compensation System 161-162

I

Identification Numbers 4-6, 111, 185

Immobilisation 31, 110, 121-124, 213

Information Centre 18-19, 21, 27, 29

Instrument Pack 8, 14-16, 21, 26-27, 38-39, 45, 74, 93, 98, 118, 129-131, 135, 143-150, 156, 161-165, 168, 170-175, 202-203, 226, 235-236, 252

Interior Door Handles 126

Interior Lights 55

Interior Locking Switch 125

ISOFIX Restraints 108-112

J

Jump Leads 170, 187

Jump Starting 187

K

KERS 9, 15, 18, 135, 157-158

Keys 31, 36, 52, 54, 88, 116-119, 122-126, 129-131

L

License Plate Lamps 179, 209, 216

Lighting Switch 35-36, 39, 210

Load Carrying 181-182

Locking 117, 122-124, 141-142, 164

M

Main Beam 27, 38, 217

Maintenance 25, 94, 95, 133, 134, 173, 222-224, 233

Manual Front Seats 81-82

Master Lighting Switch 35

Medical Advice and Awareness 138, 140

Mirrors – Door 47-48, 128, 204, 207

Mirrors – Interior 49-50

Mirrors Cleaning 250

Mirrors – Folding 48

Mislock 124-125

N

Next Service 222

Number Plate Lamps 179, 209, 216

O

Odometer 17

“One- Touch” Windows 52-53

Opening the Bonnet 225

Overspeed 20

P

Parking Aid * 178-180

Parking Camera * 179-180

Parking Brake 12, 22, 31-32, 129, 131, 151-152, 155, 165, 167-169, 193, 197, 208

Passenger Compartment Fuses 202-204

Pedestrian Alert System 24, 132, 204

Polishing the Paintwork 102, 249-252

Pollen Filter 65

Power Limitation 33, 135, 159

Power Socket 56-57

Power System 7, 12, 20, 22-29, 32-33, 47, 53, 56, 116, 121-124, 128-131, 137, 143-145, 151, 156, 158, 160-161, 166, 168-172, 177, 186, 188, 192, 195, 233

Power – Operated Windows 52-55, 128, 250

Programmed Wash/Wipe 40-41

Protection Mode 159-160

Punctured Tyres 173, 244

R

Rear Fog Lamps 27, 36, 39

Rear Seats – Folding 83, 108, 181

Rear Window Isolation Switch 52-53

Rear Wiper Replacement 241

Rear Wiper Switch and Operation 42-43

Recirculation 67-68, 70-73, 76-77

Recommended Fluids 259

Recovery 12, 190-191

Remote Key 31, 36, 54, 118-119, 122

INDEX

Remote Key Battery 31, 118

Roof Luggage Rack * 62

Routine Maintenance 173, 222-223

Running In 133

S

Safety in The Garage 223

Seat Belt Pre-Tensioners 93-94

Seat Belts 27-28, 80, 83-84, 86-99, 105-108, 114, 154, 166-168, 171, 190, 223, 252

Seat Belt Warning 28

Seat Cushion Height 81-85

Seat – Electric 82-83

Seat – Manual 81-82

Security 31, 116, 124

Side Lamps 27, 35-36

Stability Control System (SCS) 22, 29, 172, 207-208

Snow Chains 246-247

Speed Locking 126

Speedometer 16, 20

SRS Service and Replacement 102

Starting 130-131, 159, 167, 187

Steering Column Adjustment 44

Start/Stop 15, 18, 21, 128-131

Storage Devices 7, 58

Sunvisor 51

Symbols 2

T

Tailgate Opening 116, 122-123, 126

Target Speed 175-177

Technical Data 254-260

Temperature Control – ATC * 72-77

Temperature Control – ETC * 67-71

Top Tether Restraint 109

Towing Eyes 191

Towing For Recovery Precautions 190-193

Traction Control (TC) 22, 29, 172

Transporter or Trailer Recovery 190-193

Trip Computer 19

Trip Meter 17-18

Tyre Pressures 8, 19, 24, 31, 133, 173-174, 196, 198, 204, 242-245, 260

TPMS – (Tyre Pressure Monitoring System) * 24, 31,

173, 204, 245

Tyre Wear Indicators 254

Tyres 133-134, 242-246, 260

U

Unlocking 116, 122-125

USB Socket 56-57

V

Vanity Mirrors 51

Vehicle Control 135, 202, 206

Vehicle Identification Numbers 4-6

Vehicle Information Display 17-19

Vehicle Recovery 190-193

Ventilation 64-65, 69-71

VIN Plate 4

W

Warning Lights 27-34

Warning Messages 21-26

Warning Triangle 3, 184, 197

Warranty 1, 235, 249, 251

Washer Jets, Fluid and Refill 223, 237-238

Washing the Car 48, 178, 248-250

Weekly Checks 223, 228-231

Weights 256

Welcome Lights (Find My Car) 36

Wheels 163-164, 167, 172, 174, 190-193, 197, 199, 243, 245-246, 251, 260

Wheel Alignment 260

Windows 52-55

Window Lift Switch 15, 52-53

Windows – Cleaning 250

Windscreen Washer Check and Top-Up 237-238

Windscreen Wipers 40-43, 223, 237

Wiper Blade – Cleaning 239

Wiper Blade Replacement 240-241

Wiper Controls 40-43